

R&S® NGA100

Power Supply

User Manual



5601891902
Version 09

ROHDE & SCHWARZ
Make ideas real



This manual describes the following R&S®NGA100 models with firmware version 4.008 and higher:

- R&S®NGA101 One-Channel 35V/6A Power Supply 40 W (5601.8002.02)
- R&S®NGA102 Two-Channel 35V/6A Power Supply 80 W (5601.8002.04)
- R&S®NGA141 One-Channel 100V/2A Power Supply 40 W (5601.8002.03)
- R&S®NGA142 Two-Channel 100V/2A Power Supply 80 W (5601.8002.05)

In addition to the base unit, the following options are described:

- ¹ R&S®NGA-K102 Option Wireless LAN (5601.8419.03)
- R&S®NGA-K103 Option Digital I/O (5601.8425.03)

¹ Only available for instrument with serial number below 110000

© 2023 Rohde & Schwarz GmbH & Co. KG
Muehldorfstr. 15, 81671 Muenchen, Germany
Phone: +49 89 41 29 - 0
Email: info@rohde-schwarz.com
Internet: www.rohde-schwarz.com

Subject to change – data without tolerance limits is not binding.

R&S® is a registered trademark of Rohde & Schwarz GmbH & Co. KG.

Trade names are trademarks of the owners.

5601.8919.02 | Version 09 | R&S®NGA100

Throughout this manual, products from Rohde & Schwarz are indicated without the ® symbol, e.g. R&S®NGA is indicated as R&S NGA100.

Contents

1	Safety and regulatory information.....	9
1.1	Safety instructions.....	9
1.2	Labels on R&S NGA100.....	12
1.3	Warning messages in the documentation.....	13
1.4	Korea certification class A.....	14
2	Documentation overview.....	15
2.1	Manuals.....	15
2.2	Data sheet.....	15
2.3	Calibration certificate.....	16
2.4	Release notes, open source acknowledgment (OSA).....	16
3	Conventions used in the documentation.....	17
3.1	Typographical conventions.....	17
3.2	Notes on screenshots.....	17
4	Welcome to R&S NGA100.....	18
5	Getting started.....	19
5.1	Preparing for use.....	19
5.1.1	Lifting and carrying.....	19
5.1.2	Unpacking and checking.....	19
5.1.2.1	Delivery package.....	19
5.1.3	Choosing the operating site.....	19
5.1.4	Setting up the R&S NGA100.....	20
5.1.4.1	Placing the R&S NGA100 on a bench top.....	20
5.1.4.2	Mounting the R&S NGA100 in a rack.....	21
5.1.5	Considerations for test setup.....	22
5.1.6	Connecting to power.....	24
5.1.7	Switching on or off.....	25
5.1.8	Connecting to LAN.....	26
5.1.9	Connecting USB devices.....	27
5.2	Instrument tour.....	27
5.2.1	Front panel.....	28

5.2.2	Rear panel.....	29
5.2.3	Bottom panel.....	31
5.3	Trying out the instrument.....	32
5.3.1	Selecting the channels.....	32
5.3.2	Setting the output voltage and current limit.....	32
5.3.3	Activating the channel output.....	33
5.3.4	Storing/Recalling of instrument settings.....	33
5.4	Instrument control.....	33
5.4.1	Ways to operate the instrument.....	34
5.4.2	Means of manual interaction.....	34
5.4.2.1	Understanding the display information.....	34
5.4.2.2	Accessing the functionality.....	40
5.4.2.3	Entering data.....	40
5.4.3	Remote control.....	42
6	Operating basics.....	43
6.1	Front panel keys.....	43
6.1.1	Function keys.....	43
6.1.1.1	Output and channel controls.....	43
6.1.1.2	Navigation keys.....	44
6.1.1.3	Instrument functions.....	44
6.1.1.4	Memory functions.....	46
6.1.2	Navigation controls.....	46
6.1.3	Menu key.....	47
6.2	Power derating.....	50
6.3	Operation modes.....	50
7	Instrument functions.....	52
7.1	Setting the voltage and current.....	52
7.2	Activating the channel output.....	53
7.3	Current range.....	54
7.4	Remote sense function.....	57
7.5	Channel fusion.....	58
7.6	Electronic fuse.....	60
7.6.1	Activating fuse.....	60

7.6.2	Fuse delay, fuse linking.....	61
7.7	Tracking function.....	62
7.8	Protection.....	63
7.9	Digital trigger I/O.....	65
7.10	Data logging.....	69
7.11	Advanced functions.....	71
7.11.1	EasyArb.....	72
7.11.2	EasyRamp.....	74
7.12	Store and recall.....	76
7.13	Interfaces and protocols.....	78
7.13.1	Network connection.....	78
7.13.1.1	LAN connection.....	78
7.13.1.2	Wireless LAN connection.....	81
7.13.2	USB connection.....	83
7.13.3	LXI.....	86
7.13.4	SCPI.....	88
7.13.5	VISA.....	88
7.13.6	Setting up remote control connection.....	89
7.14	General instrument settings.....	90
7.14.1	Instrument information.....	90
7.14.2	General instrument settings.....	92
7.14.3	License management.....	93
7.14.4	Reset instrument.....	95
7.14.5	System test.....	96
7.14.6	Updating the firmware.....	97
7.14.7	Help.....	99
7.14.8	Date time.....	99
8	Remote control commands.....	102
8.1	Common setting commands.....	102
8.2	System commands.....	105
8.3	Configuration commands.....	109
8.3.1	Channel selecting.....	109
8.3.2	Remote sense setting.....	111

8.3.3	Voltage setting.....	111
8.3.4	Current setting.....	113
8.3.5	Combined voltage and current settings.....	114
8.3.6	Output setting.....	115
8.3.7	Fuse setting.....	119
8.3.8	OVP setting.....	123
8.3.9	OPP setting.....	126
8.4	Measurement commands.....	129
8.5	Advanced operating commands.....	130
8.5.1	Arbitrary commands.....	130
8.5.2	EasyRamp commands.....	134
8.5.3	DIO commands.....	134
8.6	Data and file management commands.....	139
8.7	Firmware update.....	141
9	Troubleshooting.....	142
9.1	Displaying status information.....	142
9.2	Problems during firmware update.....	142
9.3	Problems with remote control over LAN.....	143
9.3.1	Cannot establish a LAN connection.....	143
9.3.2	Cannot communicate over LAN.....	143
9.4	Contacting customer support.....	143
10	Transport.....	145
11	Maintenance, storage and disposal.....	146
11.1	Cleaning.....	146
11.2	Changing fuses.....	146
11.3	Internal battery replacement.....	146
11.4	Storage.....	147
11.5	Disposal.....	147
12	Applications.....	148
12.1	Parallel and series mode.....	148
12.1.1	Series mode.....	148
12.1.2	Parallel mode.....	149

Annex.....	151
A Additional basics on remote control.....	151
A.1 Messages and SCPI command structure.....	151
A.1.1 Messages.....	151
A.1.2 SCPI command structure.....	152
A.1.3 SCPI parameters.....	154
A.1.4 Overview of syntax elements.....	155
A.1.5 Responses to queries.....	156
A.2 Command sequence and synchronization.....	157
A.2.1 Preventing overlapping execution.....	157
List of commands.....	159
Index.....	161

1 Safety and regulatory information

The product documentation helps you use the product safely and efficiently. Follow the instructions provided here and in the following chapters.

Intended use

The product is intended for the development, production and verification of electronic components and devices in industrial, administrative, and laboratory environments by personnel familiar with the potential risks of measuring electrical quantities.

Use the product only for its designated purpose. Observe the operating conditions and performance limits stated in the data sheet.

Target audience

Only connect, set up and use a power supply if you are an electrically skilled person. Electrically skilled persons have the relevant education and experience to enable them to perceive risks and to avoid hazards that electricity can cause.

This document targets at all users, including installers, operators, technicians, maintenance and service personnel.

Follow the safety instructions provided in [Chapter 1.1, "Safety instructions"](#), on page 9 and the additional information provided during setup or operation procedures.

Where do I find safety information?

Safety information is part of the product documentation. It warns you of potential dangers and gives instructions on how to prevent personal injury or damage caused by dangerous situations. Safety information is provided as follows:

- In [Chapter 1.1, "Safety instructions"](#), on page 9. The same information is provided in many languages as printed "Safety Instructions". The printed "Safety Instructions" are delivered with the product.
- Throughout the documentation, safety instructions are provided when you need to take care during setup or operation.

1.1 Safety instructions

Products from the Rohde & Schwarz group of companies are manufactured according to the highest technical standards. To use the products safely, follow the instructions provided here and in the product documentation. Keep the product documentation nearby and offer it to other users.

Use the product only for its intended use and within its performance limits. Intended use and limits are described in the product documentation such as the data sheet, manuals and the printed "Safety Instructions". If you are unsure about the appropriate use, contact Rohde & Schwarz customer service.

Only people skilled in electrical work should connect, set up and use the product. Such persons have the education and experience needed to recognize risks and avoid hazards of working with electricity. These users also need sound knowledge of at least one of the languages in which the user interfaces and the product documentation are available.

Reconfigure or adjust the product only as described in the product documentation or the data sheet. Any other modifications can affect safety and are not permitted.

Never open the casing of the product. Only service personnel authorized by Rohde & Schwarz are allowed to repair the product. If any part of the product is damaged or broken, stop using the product. Contact Rohde & Schwarz customer service at <https://www.rohde-schwarz.com/support>.

Lifting and carrying the product

Look up the maximum weight in the data sheet. A single person can only carry a maximum of 18 kg safely depending on age, gender and physical condition. If your product is heavier than 18 kg, do not move or carry it by yourself.

To move the product safely, you can use lifting or transporting equipment such as lift trucks and forklifts. Follow the instructions provided by the equipment manufacturer.

Choosing the operating site

Only use the product indoors. The product casing is not waterproof. Water that enters can electrically connect the casing to live parts, which can lead to electric shock, serious personal injury or death if you touch the casing.

Unless otherwise specified, you can operate the product up to an altitude of 2000 m above sea level. The product is suitable for pollution degree 2 environments where nonconductive contamination can occur. For more information on environmental conditions such as ambient temperature and humidity, see the data sheet.

Setting up the product

Always place the product on a stable, flat and level surface with the bottom of the product facing down. If the product is designed for different positions, secure the product so that it cannot fall over.

If the product has foldable feet, always fold the feet completely in or out to ensure stability. The feet can collapse if they are not folded out completely or if the product is moved without lifting it. The foldable feet are designed to carry the weight of the product, but not an extra load.

If stacking is possible, keep in mind that a stack of products can fall over and cause injury.

If you mount products in a rack, ensure that the rack has sufficient load capacity and stability. Observe the specifications of the rack manufacturer. Always install the products from the bottom shelf to the top shelf so that the rack stands securely. Secure the product so that it cannot fall off the rack.

Connecting to power

The product is an overvoltage category II product. Connect the product to a fixed installation used to supply energy-consuming equipment such as household appliances and similar loads. Keep in mind that electrically powered products have risks, such as electric shock, fire, personal injury or even death. Replace parts that are relevant to safety only by original parts, e.g. power cables or fuses.

Take the following measures for your safety:

- Before switching on the product, ensure that the voltage and frequency indicated on the product match the available power source. If the power adapter does not adjust automatically, set the correct value and check the rating of the fuse.
- If a product has an exchangeable fuse, its type and characteristics are indicated next to the fuse holder. Before changing the fuse, switch off the product and disconnect it from the power source. How to change the fuse is described in the product documentation.
- Only use the power cable delivered with the product. It complies with country-specific safety requirements. Only insert the plug into an outlet with protective conductor terminal.
- Only use intact cables and route them carefully so that they cannot be damaged. Check the power cables regularly to ensure that they are undamaged. Also ensure that nobody can trip over loose cables.
- Only connect the product to a power source with the safety fuse specified in the data sheet.
- Ensure that you can disconnect the product from the power source at any time. Pull the power plug to disconnect the product. The power plug must be easily accessible. If the product is integrated into a system that does not meet these requirements, provide an easily accessible circuit breaker at the system level.

Working with hazardous voltages

Voltages higher than 30 V RMS, or 42 V peak, or 60 V DC are regarded as hazardous contact voltages. Direct contact with them can cause serious injuries.

When working with hazardous contact voltages, use protective measures to preclude direct contact with the measurement setup:

- Before each measurement, inspect all components for damage and replace them if necessary.
- Do not touch exposed connections and components when power is applied.
- Casing, chassis and all measuring terminals are connected to a grounding connection. Never disconnect a grounding connection on the product.
- Switch off the power before connecting or disconnecting the terminal block to the rear panel connector. Tighten all wires connected to the terminal block.
- Only use the wires and terminal blocks delivered with the product.
- Only use insulated wires, not stripped wires, for the terminal connections.
- Turn the mains switch off when the product is not in use.

- When operating measuring accessories, only use the cables delivered with the accessory. If you have to use cables from other manufacturers, make sure that they are of the required overvoltage category.

Do not operate the product in series or parallel unless that setup is supported. If accessories are provided for a product, only use them for that product. See the data sheet.

In series or parallel setups, protect yourself against electric shock before connecting access ports such as the Ethernet port or the USB port using one of the following measures:

- Ensure that all products are grounded by connecting them to the AC power.
- Disconnect all power connections to the product, including outputs.

Measurement categories

IEC 61010-2-030 defines measurement categories that rate products on their ability to resist short transient overvoltages that occur in addition to the working voltage.





This product is designed for measuring within measurement category 0 only. Measurements in this category are performed on circuits not directly connected to mains, such as electronics, battery powered circuits, and specially protected secondary circuits. This measurement category is also known as CAT I.

Cleaning the product

Use a dry, lint-free cloth to clean the product. When cleaning, keep in mind that the casing is not waterproof. Do not use liquid cleaning agents.

Meaning of safety labels

Safety labels on the product warn against potential hazards.

	Potential hazard Read the product documentation to avoid personal injury or product damage.
	Electrical hazard Indicates live parts. Risk of electric shock, fire, personal injury or even death.
	Hot surface Do not touch. Risk of skin burns. Risk of fire.
	Protective conductor terminal Connect this terminal to a grounded external conductor or to protective ground. This connection protects you against electric shock if an electric problem occurs.





1.2 Labels on R&S NGA100

Labels on the casing inform about:

- Personal safety, see "[Meaning of safety labels](#)" on page 12.

- Product and environment safety, see [Table 1-1](#).
- Device information is provided on a sticker attached to the [rear panel](#) of R&S NGA100. The sticker contains a barcode and the device ID. The device ID is a combination of the order number and the serial number.

Table 1-1: Labels regarding R&S NGA100 and environment safety

	Labeling in line with EN 50419 for disposal of electrical and electronic equipment after the product has come to the end of its service life. For more information, see " Disposing electrical and electronic equipment " on page 147.
	Grounding terminal (earth ground contact)
	ON (supply voltage)
	OFF (supply voltage)
	Chassis grounding terminal

1.3 Warning messages in the documentation

A warning message points out a risk or danger that you need to be aware of. The signal word indicates the severity of the safety hazard and how likely it will occur if you do not follow the safety precautions.

DANGER

Imminently hazardous situation. Will result in death or serious injury if not avoided.

WARNING

Potentially hazardous situation. Could result in death or serious injury if not avoided.

CAUTION

Potentially hazardous situation. Could result in minor or moderate injury if not avoided.

NOTICE

Potential risks of damage. Could result in damage to the supported product or to other property.

1.4 Korea certification class A



이 기기는 업무용(A급) 전자파 적합기기로서 판매자 또는 사용자는 이 점을 주의하시기
바라며, 가정외의 지역에서 사용하는 것을 목적으로 합니다.

2 Documentation overview

This section provides an overview of the R&S NGA100 user documentation.

2.1 Manuals

You find the documents on the R&S NGA100 product page at:

www.rohde-schwarz.com/manual/nga100

Getting started

Introduces the R&S NGA100 power supply series and describes how to set up and start working with the instrument. The printed document is delivered with the instrument.

User manual

Contains the description of all instrument modes and functions. It also provides an introduction to remote control, a complete description of the remote control commands with programming examples, and information on maintenance and instrument interfaces. Includes the contents of the getting started manual.

The *online version* of the user manual provides the complete contents for immediate display on the internet.

Basic safety instructions

Contains safety instructions, operating conditions and further important information. The printed document is delivered with the instrument.

Instrument security procedures manual

Deals with security issues when working with the R&S NGA100 in secure areas. It is available for download on the internet.

2.2 Data sheet

The datasheet contains the technical specifications of the R&S NGA100 power supply series. It also lists all options with their order numbers and accessories.

See www.rohde-schwarz.com/brochure-datasheet/nga100

2.3 Calibration certificate

The document is available on <https://gloris.rohde-schwarz.com/calcert>. You need the device ID of your instrument, which you can find on a label on the rear panel.

2.4 Release notes, open source acknowledgment (OSA)

The release notes list new features, improvements and known issues of the current firmware version, and describe the firmware installation. The open source acknowledgment document provides verbatim license texts of the used open source software. It can also be downloaded from the instrument.

See www.rohde-schwarz.com/firmware/nga100.

3 Conventions used in the documentation

3.1 Typographical conventions

The following text markers are used throughout this documentation:

Convention	Description
"Graphical user interface elements"	All names of graphical user interface elements on the screen, such as dialog boxes, menus, options, buttons, and softkeys are enclosed by quotation marks.
[Keys]	Key and knob names are enclosed by square brackets.
Filenames, commands, program code	Filenames, commands, coding samples and screen output are distinguished by their font.
<i>Input</i>	Input to be entered by the user is displayed in italics.
Links	Links that you can click are displayed in blue font.
"References"	References to other parts of the documentation are enclosed by quotation marks.

3.2 Notes on screenshots

When describing the functions of the product, we use sample screenshots. These screenshots are meant to illustrate as many as possible of the provided functions and possible interdependencies between parameters. The shown values may not represent realistic usage scenarios.

The screenshots usually show a fully equipped product, that is: with all options installed. Thus, some functions shown in the screenshots may not be available in your particular product configuration.

4 Welcome to R&S NGA100

The one-channel or two-channel power supply series are based on a classical transformer concept with high efficiency electronic pre-regulators and secondary linear regulators. This concept allows the instrument to achieve the high output power within a minimum space, high efficiency and lowest residual ripple.

The R&S NGA100 power supply series feature galvanically isolated, floating overload and short-circuit proof outputs with adjustable power ratings. The outputs can be connected in series or in parallel, thus making high currents and voltages available.

Multi-purpose protection functions are available for each channel which you can set separately, such as overcurrent protection (FUSE), overvoltage protection (OVP), over-power protection (OPP) and overtemperature protection (OTP). If such a limit is reached, the affected output channel is automatically turned off and an indicator message (FUSE, OVP, OPP or OTP) is displayed. The overcurrent protection can be linked to other channel (FuseLink function). In this case, all linked channels are turned off when the set channel reaches its limit.

The EasyArb function allows channel 1 (Ch 1) to have freely definable voltage and current sequences with a timeframe as short as 10 ms. It allows you to vary the voltage or current limit during a test sequence, for example to simulate different charging conditions of a battery. With EasyRamp function, the R&S NGA100 provides the operating condition to simulate the continuous rise of the supply voltage within a defined timeframe of 10 ms to 10 s.

Four data lines of the digital I/O interface are mutually independent and can be used as trigger input or trigger output separately. Various trigger conditions (e.g. fuse tripped, voltage, current, indicator messages) can be used to turn off, on or invert the output state when the trigger condition is met.

All R&S NGA100 power supply series are equipped with a color LCD display (320 x 240 pixels resolution). The R&S NGA100 comes with a USB interface and LAN interface.

This user manual contains a description of the functionalities that the instrument provides. The latest version is available for download at the product homepage (<http://www.rohde-schwarz.com/product/nga100>).

5 Getting started

5.1 Preparing for use

Here, you can find basic information about setting up the product for the first time.

5.1.1 Lifting and carrying

See "[Lifting and carrying the product](#)" on page 10.

5.1.2 Unpacking and checking

1. Unpack the R&S NGA100 carefully.
2. Retain the original packing material. Use it when transporting or shipping the R&S NGA100 later.
3. Using the [delivery package](#) list, check the equipment for completeness.
4. Check the equipment for damage and loose parts.

If the delivery is incomplete or equipment is damaged, contact Rohde & Schwarz.

See also [Chapter 10, "Transport"](#), on page 145.

5.1.2.1 Delivery package

The delivery package contains the following items:

- R&S NGA100 power supply preloaded with two 230 V fuses
- Four power cables
- Two 115 V fuses (replace the preloaded fuses with these fuses depending on the mains voltage, see "[Replacing the power fuse](#)" on page 24 for more information)
- One 5-pin plug (P/N: 3643.6463.00) for digital I/O port connections
- One 8-pin terminal block plug (P/N: 3660.3381.00) for output connections
- One Getting Started manual
- One document folder with multilingual safety instruction and CE certificate

5.1.3 Choosing the operating site

Specific operating conditions ensure proper operation and avoid damage to the product and connected devices. For information on environmental conditions such as ambient temperature and humidity, see the data sheet.

See also "[Choosing the operating site](#)" on page 10.

Electromagnetic compatibility classes

The electromagnetic compatibility (EMC) class indicates where you can operate the product. The EMC class of the product is given in the data sheet.

- Class B equipment is suitable for use in:
 - Residential environments
 - Environments that are directly connected to a low-voltage supply network that supplies residential buildings
- Class A equipment is intended for use in industrial environments. It can cause radio disturbances in residential environments due to possible conducted and radiated disturbances. It is therefore not suitable for class B environments. If class A equipment causes radio disturbances, take appropriate measures to eliminate them.

5.1.4 Setting up the R&S NGA100

Adequate air circulation must be ensured during operation. For continuous operation, a horizontal or inclined position (integrated stand) is preferable.

See also:

- "[Setting up the product](#)" on page 10
- "[Intended use](#)" on page 9

5.1.4.1 Placing the R&S NGA100 on a bench top

To place the product on a bench top

1. Place the product on a stable, flat and level surface. Ensure that the surface can support the weight of the product. For information on the weight, see the data sheet.
2. **CAUTION!** Foldable feet can collapse. See "[Setting up the product](#)" on page 10. Always fold the feet completely in or out. With folded-out feet, do not place anything on top or underneath the product.
3. **WARNING!** A stack of products can fall over and cause injury. Never stack more than three products on top of each other. Instead, mount them in a rack.

Stack as follows:

- If the products have foldable feet, fold them in completely.
- All products must have the same dimensions (width and length).
- Do not exceed a total load of 50 kg placed on the product at the bottom of the stack.

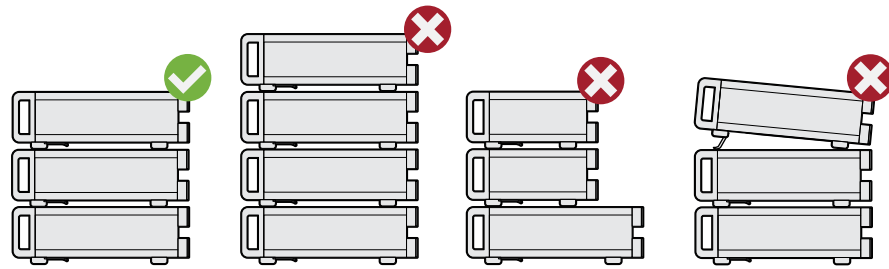

- Left = Stacked correctly
 Middle left = Stacked incorrectly, too many products
 Middle right = Stacked incorrectly, different dimensions
 Right = Stacked incorrectly, folded-out feet

4. **NOTICE!** Overheating can damage the product.

Prevent overheating as follows:

- Keep a minimum distance of 10 cm between the fan openings of the product and any object in the vicinity to provide sufficient airflow and ventilation.
- Do not place the product next to heat-generating equipment such as radiators or other products.

5.1.4.2 Mounting the R&S NGA100 in a rack

To prepare the rack

1. Observe the requirements and instructions in "[Setting up the product](#)" on page 10.
2. **NOTICE!** Insufficient airflow can cause overheating and damage the product.

The heat produced inside the instrument is guided to the exterior via temperature-controlled fan. The R&S NGA100 has multiple temperature sensors which check the heat generation in the instrument and control the fan speed.

It is necessary to ensure that there is sufficient space around the instrument sides for heat exchange. Ensure that fan openings and ventilation holes are unobstructed and airflow vents are unimpeded.

If the temperature inside the instrument increases more than the allowed limit, over-temperature protection is triggered and the affected outputs are switched off automatically.

To mount the R&S NGA100 in a rack

1. Use an adapter kit that fits the dimensions of the R&S NGA100 to prepare the R&S NGA100 for rack mounting.
 - a) Order the R&S HZN96 rack adapter kit (P/N: 3638.7813.02) designed for the R&S NGA100.
 - b) Mount the adapter kit. Follow the assembly instructions provided with the adapter kit.
2. Lift the R&S NGA100 to shelf height.

3. Push the R&S NGA100 onto the shelf until the rack brackets fit closely to the rack.
4. Tighten all screws at the rack brackets with a tightening torque of 1.2 Nm to secure the R&S NGA100 at the rack.

To unmount the R&S NGA100 from a rack

1. Loosen the screws at the rack brackets.
2. Remove the R&S NGA100 from the rack.
3. If placing the R&S NGA100 on a bench top again, unmount the adapter kit from the R&S NGA100. Follow the instructions provided with the adapter kit.

5.1.5 Considerations for test setup

The product is built in compliance with DIN EN 61010-1 (VDC 0411 part 1), EN 61010-1 and IEC 61010-1. It is designed with the regulations of protection class 1, for supplying power-on circuits that are only indirectly connected to the low voltage mains or not connected at all.

The instrument is not intended for measurements within the measurement categories II, III or IV; the maximum potential against earth generated by the user must not exceed 250 VDC in this application.

See also "[Measurement categories](#)" on page 12.

General instrument specification

See [Table 5-1](#) for the general data on the instrument specification. Refer to the instrument datasheet for details.

Table 5-1: General data on instrument specification

Mains nominal voltage	AC	100 V / 115 V / 230 V ($\pm 10\%$) 50 Hz / 60 Hz
Power consumption	Maximum input power	230 W
Mains fuses (fuse size: 5 mm x 20 mm)	100 V / 115 V AC	IEC 60127 T5.0H250V
	230 V AC	IEC 60127 T2.5H250V
Temperature	Operating temperature range	5 °C to + 40 °C
	Storage temperature range	- 20 °C to + 70 °C
Humidity	Non-condensing	5 % to 80 %
Display		3.5 " (QVGA)
Rack mount capability		R&S HZN96 rack adapter 2U (P/N: 3638.7813.02)
Dimensions	W x H x D	222 mm x 96 mm x 446 mm (8.74 in x 3.78 in x 17.56 in)

Weight	R&S NGA101, R&S NGA141	6.6 kg (14.55 lb), 6.9 kg (15.21 lb)
	R&S NGA102, R&S NGA142	7.0 kg (15.43 lb), 7.3 kg (16.09 lb)

Operating limits

The R&S NGA100 is equipped with a protective overload feature. The protective overload feature prevents damage to the instrument and is intended to protect against a possible electrical shock. The maximum values for the instrument must not be exceeded. The protection limits are listed on the front panel of the R&S NGA100 to ensure safe operation of the instrument.

See [Table 5-2](#) for protection limits of the R&S NGA100.

Table 5-2: Protection limits for R&S NGA100

Specification	Limits
Maximum output voltage	35 V module: 35.00 VDC 100 V module: 100.00 VDC
Maximum output current	35 V module: 6.0 100 V module: 2.0
Maximum voltage against earth	250 VDC
Maximum reverse voltage	35 V module: 36.00 VDC 100 V module: 102.00 VDC
Maximum inverse voltage	0.4 VDC
Maximum permitted current in case of inverse voltage	35 V module: 6.00 A 100 V module: 2.00 A
Power supply	100 VAC, 115 VAC or 230 VAC (tolerance $\pm 10\%$)
Frequency	50 Hz / 60 Hz
Maximum power output	40 W (R&S NGA101, R&S NGA141) 80 W (R&S NGA102, R&S NGA142)

Cable selection and electromagnetic interference (EMI)

Electromagnetic interference (EMI) can affect the measurement results.

To suppress electromagnetic radiation during operation:

- Use high-quality shielded cables, for example double shielded USB and LAN cables.
- Use at least a CAT6+ LAN cables with a length ≤ 3 m and passive USB cable with a length ≤ 1 m.
- Use insulated wires for output supply/terminal connections.
- Always terminate open cable ends.
- Ensure that connected external devices comply with EMC regulations.
- Check regularly that all cables, including power cables are in perfect conditions.

Signal input and output levels

Information on voltage levels is provided in the data sheet. Keep the voltage levels within the specified ranges to avoid damage to the product and connected devices.

See also "[Output terminals](#)" on page 31.

5.1.6 Connecting to power

For safety information, see "[Connecting to power](#)" on page 11 and "[Working with hazardous voltages](#)" on page 11.

Before connecting the instrument to the mains, check whether the mains voltage conforms to the mains voltage range specified on the label located at the left of the [AC power connector](#).

Check also that the mains voltage corresponds to the [voltage selector](#) at the bottom panel.

The power supply module covers a wide power supply range and normally does not require adjustment. See [Table 5-1](#) for the supported mains voltage and the corresponding fuse types and ratings. If the power supply exceeds the permissible range, contact Rohde & Schwarz customer service.

1. Ground the R&S NGA100 using the ground terminal on the rear panel. See "[Ground terminal](#)" on page 25.
2. Plug the AC power cable into the AC power connector.
Use power cable that complies with the IEC 60320-1 standard.
3. Plug the AC power cable into a power outlet with ground contact.
The required ratings are listed next to the AC connector and in the data sheet.

Replacing the power fuse

By default, the R&S NGA100 is preloaded with two time lag fuses (IEC 60127 T2.5H250V). The fuse holder is located below the AC power connector.

1. Disconnect the product from the power source by removing the power cable from the power plug on the rear panel of the R&S NGA100.

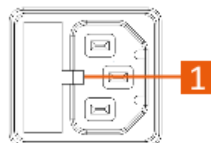



Figure 5-1: AC power connector

1 = Small notch of the fuse holder

2. Insert a flathead screwdriver in the small notch at the top of the fuse holder.
3. Lever out the fuse holder with the screwdriver.

4. Check the fuse rating on the caps of both fuses that you want to replace.
5. Once verified, insert the fuse into the groove of the fuse holder.
6. Return the fuse holder to its position in the panel.
The fuse holder is inserted against the spring pressure until it locks into place.

Ground terminal

If necessary, ground the instrument using the grounding connection  located at the [rear panel](#):

1. Unscrew the screw of the ground terminal using a cross-recess screw driver.
2. Attach a ground cable with a ring terminal and pass the screw through it.
3. Fasten the screw with a tightening torque of 1.2 Nm.
4. Connect the cable to ground.

5.1.7 Switching on or off



Specifications with tolerance data apply after a warm-up period of at least 30 minutes at a temperature of 23 °C (tolerance -3 °C / +7 °C).

Before switching on the instrument, check that the [voltage selector](#) corresponds to the mains voltage. See [Table 5-1](#) for the available mains voltage.

See also [Chapter 5.1.6, "Connecting to power"](#), on page 24.

Switching on the product

The product is off but connected to power.

- ▶ Press the [Power] key on the [front panel](#) of the R&S NGA100.

The instrument performs a system check, boots the operating system and starts the R&S NGA100 firmware.

By default, the output channel is turned off when the instrument is switched on to prevent connected loads from being damaged unintentionally.

During startup, the R&S NGA100 is loaded with the last auto-saved parameters.

See [Chapter 7.12, "Store and recall"](#), on page 76 in the user manual.

Shutting down and disconnecting R&S NGA100 from power



For safety reason, switch off at the mains switch when the instrument is not in use.

1. Press [Power] key.
The operating system shuts down.

2. Disconnect the AC power cable from the socket outlet.

5.1.8 Connecting to LAN

Establishing the LAN connection

The R&S NGA100 provides Ethernet (LAN) connectivity. Provided the corresponding rights are assigned, you can use these interfaces for remote control and data transfer from a controller PC. The controller PC must also be connected in the network.

The LAN connector is at the [rear panel](#) of R&S NGA100.

To connect R&S NGA100 to the LAN:

1. **NOTICE!** Recommendation on secure operation. The R&S NGA100 is designed to operate at local workplaces or in secured networks (LAN). It should not be accessible from the internet because of a potential security risk, e.g. attackers could misuse or damage your device.

Please always install the latest firmware.

By default, the R&S NGA100 configuration uses DHCP that assigns the IP address automatically.

2. Connect the LAN socket using an RJ-45 cable to the LAN.
3. **NOTICE!** If the R&S NGA100 cannot obtain an IP address automatically, or cannot establish the connection, the status shows "Disconnected" in the [Figure 5-2](#). Possible reasons are that the LAN does not support DHCP or requires a specific TCP/IP configuration, or that the connection is missing.

To troubleshoot the problem, proceed as follows:

- a) Check if you have connected both, the R&S NGA100 and the controller PC to the LAN.
- b) Consult your network administrator to request support for an IP address, if necessary.
- c) If necessary, assign the IP address manually as described in [Chapter 7.13.1.1, "LAN connection"](#), on page 78.

If switched on and connected, the R&S NGA100 indicates the address information and LAN parameters in the Ethernet setting dialog. See [Figure 5-2](#).

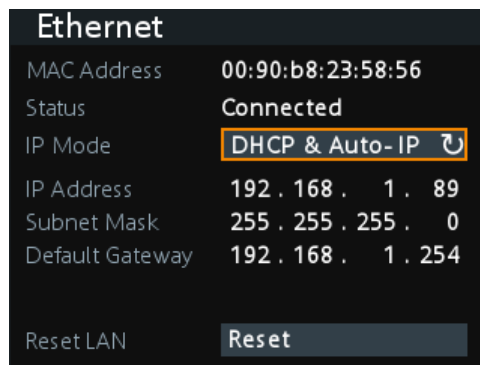

Figure 5-2: Ethernet settings dialog

5.1.9 Connecting USB devices

The USB Type-A connector is at the [front panel](#). You can connect or disconnect all USB devices from the R&S NGA100 during operation. But do not remove an external USB memory stick while the instrument is performing firmware update, data logging and storing of screen captures, since it leads to unsuccessful updates and loss of data.

To connect USB storage devices

USB storage devices, such as memory sticks, allow easy data transfer from or to the R&S NGA100. You can also use them for firmware updates.

- ▶ Connect the USB storage device to the USB type A connector.
If you use the front panel connectors, connect the USB storage device directly, without connecting cable. Connecting cables can cause electromagnetic radiation and impair the measurement result.

5.2 Instrument tour

The following sections help you to get familiar with the instrument and perform the first steps:

- [Chapter 5.2.1, "Front panel"](#), on page 28
- [Chapter 5.2.2, "Rear panel"](#), on page 29
- [Chapter 5.2.3, "Bottom panel"](#), on page 31

These sections explain the controls and connections on the front, rear and bottom of the R&S NGA100. For specifications of the interfaces, see the data sheet.

The meanings of the labels on the R&S NGA100 are described in [Chapter 1.2, "Labels on R&S NGA100"](#), on page 12.

5.2.1 Front panel

The front panel of the R&S NGA100 is as shown in [Figure 5-3](#). The function keys and navigation controls are located at the right side of the display. The various connectors are located below the display and function keys.

Table 5-3: Power supply models

Models	Number of output channels
R&S NGA101 (0 V - 35 V/6 A), R&S NGA141 (0 V - 100 V/2 A)	1 (maximum 40 W)
R&S NGA102 (0 V - 35 V/6 A), R&S NGA142 (0 V - 100 V/2 A)	2 (maximum 80 W)

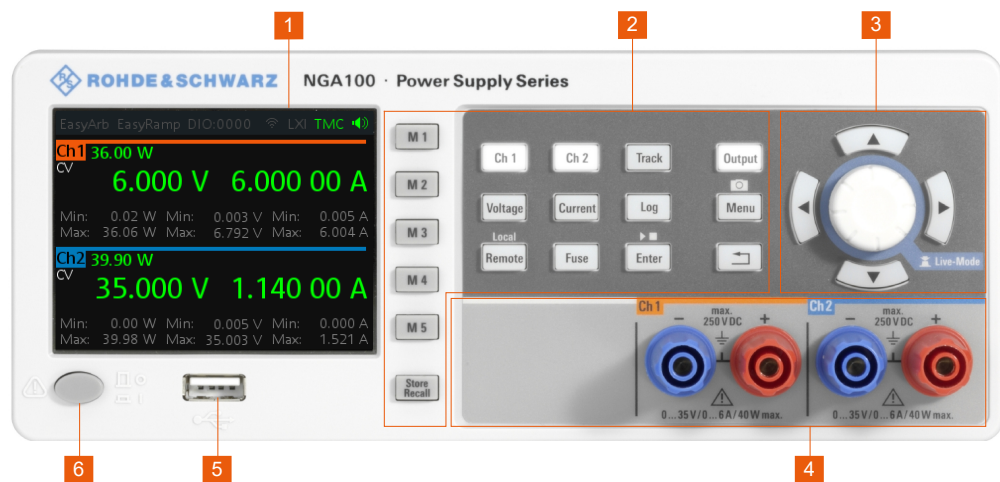

Figure 5-3: Front panel of R&S NGA100 with two channels

- 1 = Display
- 2 = Function keys
- 3 = Rotary knob and arrow keys
- 4 = Output channels (see [Table 5-3](#))
- 5 = USB connector
- 6 = Power key

Display (1)

The display is a color LCD screen. Depending on the instrument models, up to two channels are shown on the screen. The respective measurement settings and functions are displayed in the individual channel section. There is a status bar above the channel section to indicate the functions used and operation mode of the instrument.

For a detailed description on-screen layout, see [Chapter 5.4.2.1, "Understanding the display information"](#), on page 34.

Function keys (2)

Function keys are means of input for manual operation of the instrument functions. When a function key is pressed, all the related keys are also illuminated.

For detailed description on function keys, see [Chapter 6.1.1, "Function keys"](#), on page 43.

Rotary knob and arrow keys (3)

Rotary knob and arrow keys are means of navigation and adjustment. When pressed or rotated, they perform tasks like navigation around the screen, adjustment of parameter values or confirmation of entries.

For detailed description on rotary knob and arrow keys, see [Chapter 5.4.2, "Means of manual interaction"](#), on page 34.

Output channels (4)

Depending on the instrument models, up to two output channels are available for output of power to the connected load. See [Table 5-3](#).

See also ["Output terminals"](#) on page 31.

USB connector (5)

USB Type-A connector is provided for connecting a USB flash drive to perform firmware update, data logging and store screen captures.

The USB flash drive file system supports FAT32 only. See also [Chapter 5.1.9, "Connecting USB devices"](#), on page 27.

Power key (6)

The [Power] key switches the instrument on and off, see [Chapter 5.1.7, "Switching on or off"](#), on page 25.

5.2.2 Rear panel

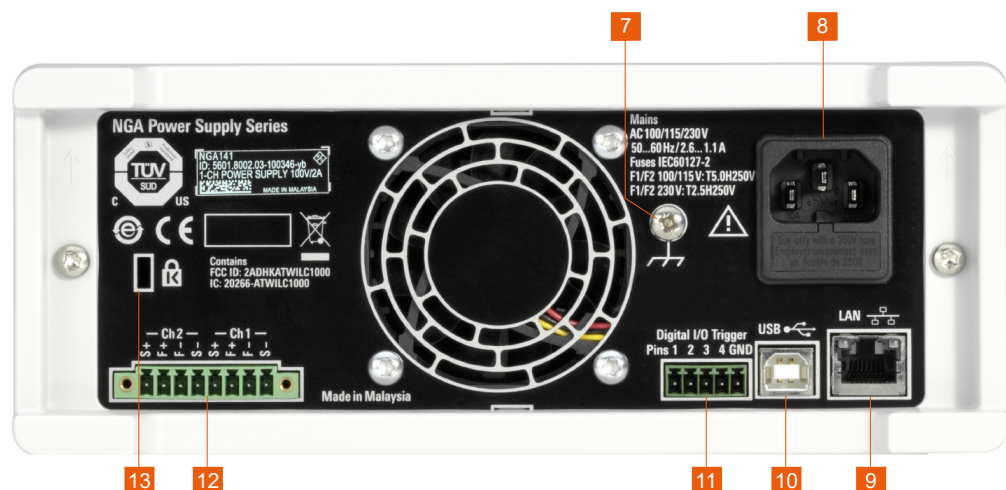

Figure 5-4: Rear panel of R&S NGA100

- 7 = Ground terminal
- 8 = AC inlet with fuse holder
- 9 = Ethernet (LAN) connector
- 10 = USB connector
- 11 = Digital I/O connector
- 12 = Rear panel connector
- 13 = Kensington lock

Ground terminal (7)

Protective ground terminal to secure the R&S NGA100, e.g. with a ground external conductor, see [Chapter 1.2, "Labels on R&S NGA100"](#), on page 12.

AC inlet with fuse holder (8)



Main supply cord

Use a detachable mains supply cord according to IEC60320-1 standard. Never use the product if the power cable is damaged.

Main power supply with fuse holder and IEC socket.

- Fuse holder
Socket for the fuse securing the line voltage. The fuse is factory fitted. See ["Replacing the power fuse"](#) on page 24.
- IEC socket
Power supply connector for connecting the R&S NGA100 to the mains, see [Chapter 5.1.6, "Connecting to power"](#), on page 24.

Ethernet connector (9)

This connector is used for establishing remote control via SCPI. For more information on the connection setup, see [Chapter 5.1.8, "Connecting to LAN"](#), on page 26.

USB connector (10)

The USB connector is a Type-B connector for remote control operation via USB TMC or USB VCP.

For more information, see [Chapter 7.13.2, "USB connection"](#), on page 83.

Digital I/O connector (11)

NOTICE

Risk of instrument damage

Do not exceed the maximum voltage rating of the digital I/O pins (5.25 V max) when supplying voltages to the pins.

The digital I/O is a 5-pin terminal block for external trigger input or output.

Measurement control for digital I/O can be achieved with an external input signal or as an output signal to trigger other instruments for measurements.

The digital trigger I/O option (R&S NGA100-K103) must be installed for this function to be available in the instrument.

For more information, see [Chapter 7.9, "Digital trigger I/O"](#), on page 65.

Rear panel connector (12)

NOTICE

Output terminals

Either the output terminals at the front panel or the rear panel connector at the back panel can be used.

Both terminals cannot be used at the same time as it can cause the instrument to malfunction.

The rear panel connector contains both output ("F+", "F-") and sense ("S+", "S-") connections. Connector for "Ch 2" is only available in the R&S NGA102, R&S NGA142 models.

1. **DANGER!** Shock Hazard. Risk of electric shock if AC power is turned on when connecting wires to the rear panel connector.
Turn off AC power when connecting wires to the rear panel connector.
2. Insert shielded wire to the pluggable terminal block.
3. Tightened all the wires with the screw on the pluggable terminal block.
4. Connect the pluggable terminal block to the output terminal.

Kensington security slot (13)

A Kensington lock can be anchored to the R&S NGA100 power supply housing to secure it to a workstation mechanically.

5.2.3 Bottom panel

The voltage selector is located at the bottom panel. On your first power-on connection, you should see a yellow label sticker attached over the [AC inlet](#). Before peeling off the yellow label sticker, make sure that the correct fuse rating is used for the mains voltage.

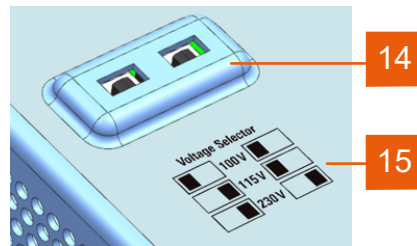

Figure 5-5: Bottom panel of R&S NGA100

14 = Voltage selector

15 = Voltage selector label

Voltage selector (14), Voltage selector label (15)

The voltage selector selects the mains voltage between 100 V, 115 V and 230 V. See [Table 5-1](#) for the fuse rating.

To set the correct fuse rating, use a tool e.g. a flat screwdriver to move the selector according to the voltage selector label.

- To select 100 V, slide both voltage selector to the left
- To select 115 V, slide both voltage selector facing inward
- To select 230 V, slide both voltage selector to the right

5.3 Trying out the instrument

This chapter describes some basic functions that you can perform with the R&S NGA100.

5.3.1 Selecting the channels

To select a channel, press the corresponding channel key. The selected channel key illuminates.

5.3.2 Setting the output voltage and current limit

To set the output voltage and current limit via live-mode:

1. Long press the rotary knob to enter into editing mode.
By default, the voltage at channel 1 is selected.
2. Use arrow keys to select the desired parameter (voltage or current).
3. Rotate the rotary knob to adjust value.

4. To exit live-mode, press the rotary knob.

Alternatively:

1. Press [Voltage] or [Current] key on the front panel.
2. For the two-channel R&S NGA100, press the desired channel key to activate the respective voltage or current limit setting of that channel. The value on the respective channel becomes editable and is positioned by a blue cursor.
3. Press the [Left] / [Right] arrow key to move the cursor.
4. Press the [Up] / [Down] arrow key to change the value.
Alternatively, turn the rotary knob to change the value.
The new value registers immediately.

5.3.3 Activating the channel output

The output voltages can be switched on or off regardless of the operating mode of the instrument.

To activate the channel output, press the [Output] key on the front panel followed by the desired channel key or vice versa.

For single channel models, press the [Output] key to activate the channel output.

Depending on the instrument operating mode, the display font color changes to green in CV (constant voltage) mode and red in CC (constant current) mode.

By default, the output is turned off when the instrument is switched on.

See also "[Operating mode](#)" on page 38.

5.3.4 Storing/Recalling of instrument settings

The instrument settings can be stored in the instrument memory by long pressing the [Store Recall] key followed by the desired memory location key ([M1] to [M5]). The previous saved settings are overwritten.

To retrieve the settings, press [Store Recall] key and select the desired memory location key ([M1] to [M5]).

5.4 Instrument control

This chapter provides an overview on how to work with the R&S NGA100. It introduces the possibilities for operating the instrument and describes the basic functionality of the control elements. If a measurement configuration requires specific operating steps, the corresponding settings description in the user manual points it out separately.

- [Ways to operate the instrument](#)..... 34
- [Means of manual interaction](#)..... 34
- [Remote control](#).....42

5.4.1 Ways to operate the instrument

You can operate an R&S NGA100 in two ways:

- **Manual operation**
Use the front panel controls to configure the R&S NGA100 settings.
See [Chapter 5.4.2, "Means of manual interaction"](#), on page 34 for basic information on manual operation of the instrument.
- **Remote control**
Create programs to automatize repeating settings, tests and measurements. A controller PC with remote access to the instrument runs the programs.
See [Chapter 5.4.3, "Remote control"](#), on page 42 for an overview of the interfaces provided for remote control.

5.4.2 Means of manual interaction

For manual interaction with the R&S NGA100, you have several methods that you can use as an alternative to perform a task:

- **Memory, menu and function keys**
The front panel function keys provide all the functions and controls needed to operate the instrument.
You can access to the different instrument functions and parameters settings, operating modes and configure general instrument settings.
- **Navigation controls**
The navigation controls include a rotary knob and arrow keys ([Up], [Down], [Left], [Right]).
The arrow keys allow you to navigate on the channel display screen or dialogs to set parameters.

For basic instructions on how to control the R&S NGA100, see [Chapter 5.4.2.2, "Accessing the functionality"](#), on page 40.

5.4.2.1 Understanding the display information

The initial display screen shows the [channel display area](#), [status bar information](#) and [historical channel information](#). The channel area displays the voltage, current values and [operating mode](#) of the output.

For detailed information, see [Chapter 6.3, "Operation modes"](#), on page 50.

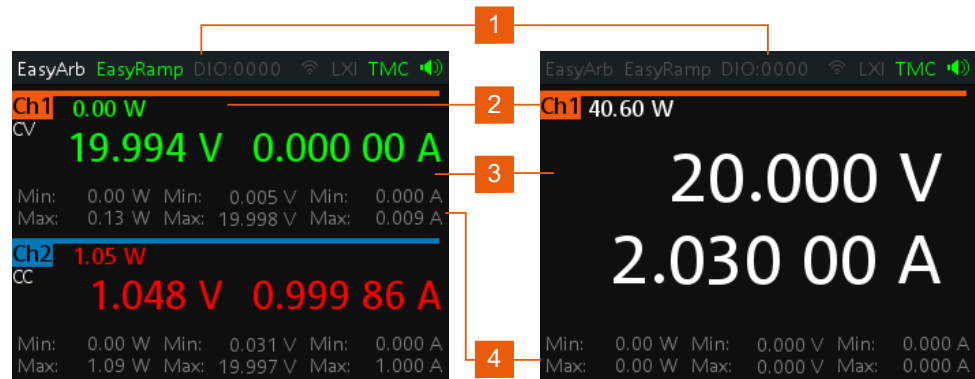

Figure 5-6: Example of screen display

- 1 = Device status bar
- 2 = Channel status bar
- 3 = Channel display area
- 4 = Historical channel information

The following sections explain the information areas as labeled.

Status bar information

There are two types of status bar information located at the top of the screen layout:

- Device status
- Channel status

Device status

The device status displays the state of the functions activated in the device.

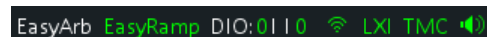



Figure 5-7: Device status bar

Table 5-4: Device status bar information

Function	Description
EasyArb	Arbitrary output sequences on Ch 1. If in use, the icon is highlighted in green. If enabled, the icon is highlighted in white else it shows gray.
EasyRamp	Output voltage to ramp continuously within a 10 ms to 10 s until set voltage, V_{set} . If in use, the icon is highlighted in green (with output turns on). If enabled, the icon is highlighted in white else it shows gray.

Function	Description
DIO:xxxx	Digital trigger I/O (digital trigger I/O option R&S NGA100-K103 must be installed). The "xxxx" refers to I/O status for DIO1, DIO2, DIO3, DIO4. If in use, the icon is highlighted in green. If enabled, the icon is highlighted in white. If disabled or option not installed, the icon is highlighted in gray.
	Wireless LAN connection (WLAN option R&S NGA100-K102 must be installed). Available only with instrument serial number below 110000. If connected to access point, the icon is highlighted in green. It shows yellow when connecting to access point. If disconnected or disabled, the icon is highlighted in gray.
LXI	Wired LAN connection with LXI service for remote control operation. If LAN/LXI is in operation, the icon is highlighted in green. If LAN/LXI is in fault, the icon is highlighted in gray.
TMC/VCP	USB connection with USB-VCP or USB-TMC setting. If TMC or VCP is selected, the icon is highlighted in green.
	Indicate buzzer state ("Disabled", "Fault Events", "Any Events"). If speaker is enabled, the icon is highlighted in green, else it shows gray.

Channel status

The channel status displays the state of the indicators available in the device channel.

Ch1 40.60 W PAR **SNS** OPP OTP FUSE

Figure 5-8: Channel status bar

Table 5-5: Channel status bar information

Indicator	Description
Channel number	Channel number indication.
Power	Display output power in watt.
SER/PAR	Indicator to show the series or parallel mode if channel fusion is enabled. Available only for the two-channel models. If enabled, the indicator displays in white.
SNS	Remote sense status indication. If enabled, the indicator displays in green.

Indicator	Description
OVP / OPP / OTP	Indicator to show that the overload voltage, power or temperature protection is triggered. When triggered, the indicator shows flashing and displays in red. The OVP and OPP indicators are located in the same position. If both are triggered at the same time, the indicator flashes between OVP and OPP.
Fuse	Indicator to show the fuse status (on or off). When triggered, the indicator shows flashing and displays in red.

Channel display area

The R&S NGA100 displays two channels display area (Ch 1, Ch 2) for R&S NGA102 and R&S NGA142 and a single channel display area for R&S NGA101 and R&S NGA141.

The channel display area shows the voltage and current values and the corresponding operating mode (CC, CV) of the R&S NGA100 when the device output is turned on. See "[Operating mode](#)" on page 38 for the different operating modes that the R&S NGA100 supported.

Historical channel information

The historical information at the bottom of the channel display area shows the maximum and minimum values for power ("W"), voltage ("V") and current ("A").

To reset the historical channel information, long press on the  [BACK] key.

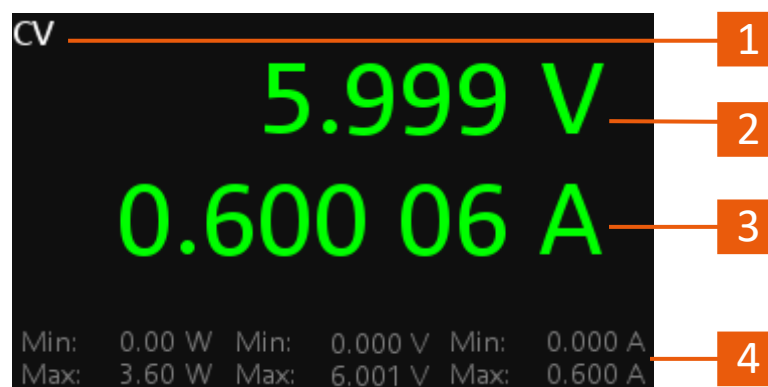

Figure 5-9: Channel display area for one-channel model

- 1 = [Operating mode](#).
- 2 = Output voltage displays in volt. The display resolution for voltage is three digits after the decimal point.
- 3 = Output current displays in ampere. The display resolution for current is five digits after the decimal point.
- 4 = [Historical channel information](#).

To change the voltage or current value, see "To correct value in the channel display area" on page 41.

Operating mode

Different font colors on the screen are used to differentiate the various output status and operating conditions of the instrument. It is easy to know and confirm the different output status and operating conditions of the instrument by looking at the colors.



Figure 5-10: Color coding of difference operating conditions

Color	Operating mode	Description
□	OFF mode	Output is OFF.
■	Editing mode	A solid blue cursor is shown when an item is selected. All cursor keys are also lit up.
■	CV mode	Active outputs are operated in a constant voltage mode. Label "CV" is displayed at the top left-hand corner below channel number.
■	CC mode	Active outputs are operated in a constant current mode. Label "CC" is displayed at the top left-hand corner below channel number.

Additional display characteristics

The following section provides a short insight on the indication of the screen in general in dialogs or settings.

- Appearance of active elements
 - Elements selected have a blue background. In channel display area, the selected element (Voltage or Current) is in editing mode.
 - Selected element pending for editing are highlighted in orange frame with a rotary icon and selection of data is via the rotary knob.

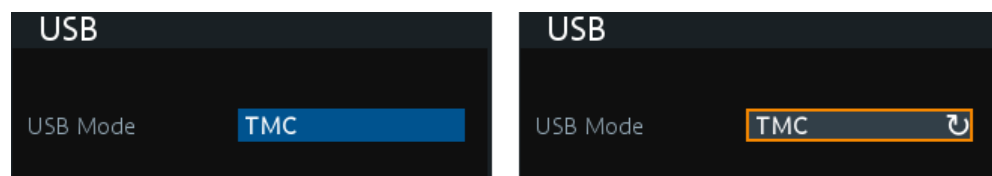

- Menus and dialogs

Other than the corresponding hardkey functions located at the instrument front panel, all other functions are accessed via the [MENU] key. When pressed, the R&S NGA100 displays the menu.

The instrument functions are grouped into the various menus based on the categories of "Output", "Interface", "Device" and "Utilities". For more information, see [Chapter 6.1.3, "Menu key"](#), on page 47.

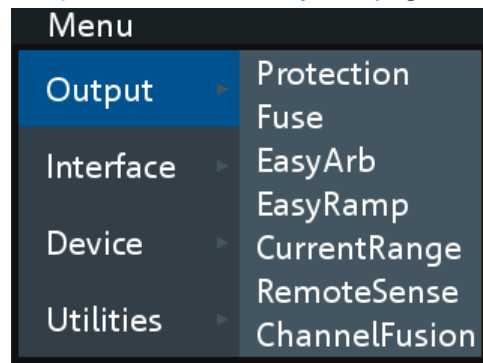

Figure 5-11: Example of a menu selection

The term dialog refers to the views that cover the parameters of a certain function.

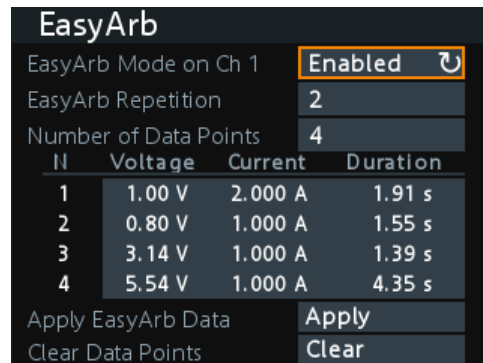

Figure 5-12: Example of a dialog

- On-Screen keypad

The on-screen keypad appears if alphanumeric entry field is required. See ["Entering alphanumeric parameters"](#) on page 41.



Figure 5-13: On-screen keyboard

5.4.2.2 Accessing the functionality

All functionalities of the R&S NGA100 are provided by the corresponding functions keys on the front panel. This section provides an overview of the accessing methods. For detailed information, see [Chapter 6.1.1, "Function keys"](#), on page 43.

Apart from the main menu, we use the term "dialog" to refer the editable windows in the instrument.

To open the menu

1. Press [Menu] key at the front panel.
The main menu of the instrument is displayed.
2. Rotate the rotary knob or press the [UP] / [DOWN] arrow key to navigate the menu.
3. Press the rotary knob or [Enter] key on the front panel to confirm the selection.
The selected dialog is opened for setting.

To close or exit a dialog or menu

- ▶ Press  [Back] key at the front panel.
The instrument returns to previous menu level or exit the menu mode if it is already at the main menu level.

To select a parameter in a dialog

All except the arbitrary editor dialogs have its parameters fixed in a single view. For arbitrary editor dialog, the number of data points indicate the available rows of data for selection:

1. Rotate the rotary knob or press the [UP] / [DOWN] arrow key to navigate.
2. Press the rotary knob or [Enter] key to confirm your selection.

To go into live-mode

In live-mode, the instrument automatically sets the voltage to editing mode. Duration of the live-mode depends on the key fallback time. Set a longer key fallback time if you need more time in this mode.

For information, see [Chapter 7.14, "General instrument settings"](#), on page 90.

For more information on live-mode operation, see [Chapter 5.3.2, "Setting the output voltage and current limit"](#), on page 32.

5.4.2.3 Entering data

Data can be entered using one of the following methods:

- Using the navigation controls on the front panel, e.g. rotary knob, arrow keys
 - The rotary knob acts like the [ENTER] key when it is pressed.

- Long press on the [UP] / [DOWN] arrow key to increase or decrease the value to maximum or minimum value.
Press rotary knob to stop.
- Using on-screen keyboard for alphanumeric input field in the dialog

Entering numeric parameters

If the input field requires numeric input, you can use either the rotary knob or arrow keys on the front panel to adjust to required values.

To correct value in a dialog

1. Rotate the rotary knob to increase (clockwise direction) or decrease (counter-clockwise direction) to the required value.
2. Alternatively, use the [Up] arrow key to increase and [Down] arrow key to decrease to the required value.

To correct value in the channel display area

1. Select the corresponding function key at the front panel, e.g. select [Voltage] key for voltage setting.
2. Press the [Left] / [Right] arrow key to position at the entry point for correction.
3. Rotate the rotary knob to increase (clockwise direction) or decrease (counter-clockwise direction) to the required values.
4. Alternatively, use the [Up] arrow key to increase and [Down] arrow key to decrease to the required value.

To complete the entry

- ▶ Press the rotary knob and returns to the previous screen.

Entering alphanumeric parameters

If a field requires alphanumeric input, you can use the on-screen keyboard to enter letters and (special) characters.

To correct an entry

1. To delete an entry, set the cursor to the right of the entry you want to correct.
2. Press rotary knob to display on-screen keyboard.
3. Use the arrow keys or rotate the rotary knob to go to the desired character on the on-screen keyboard.
4. Select  to delete the entry to the left of the cursor. Alternatively, select "CLR" to delete the current entry.
5. Enter your correction.

To complete the entry

To confirm the entry:

- ▶ On the on-screen keyboard, select "OK" to confirm the input.

The dialog closes with changes to the settings.

Pressing the rotary knob also confirms the action and returns to the previous screen.

To abort the entry

- ▶ On the on-screen keypad, select "ESC".

The dialog closes without changing the settings.

To alternate between lowercase and uppercase

- ▶ On the on-screen keypad, select .

5.4.3 Remote control

In addition to operating the R&S NGA100 directly on the instrument, it is also possible to operate and control it from a remote PC.

Remote control interfaces

The R&S NGA100 provides several interfaces for remote control:

- Ethernet (LAN) interface
- USB standard interface

For detailed information on how to configure the remote control interfaces, see [Chapter 7.13, "Interfaces and protocols"](#), on page 78.

See [Chapter 5.1.8, "Connecting to LAN"](#), on page 26 for an example of how to set up LAN connection for remote control.

6 Operating basics

6.1 Front panel keys

For an overview of the front panel keys, see [Chapter 5.2, "Instrument tour"](#), on page 27.

6.1.1 Function keys

The following keys can be categorized based on their functions.

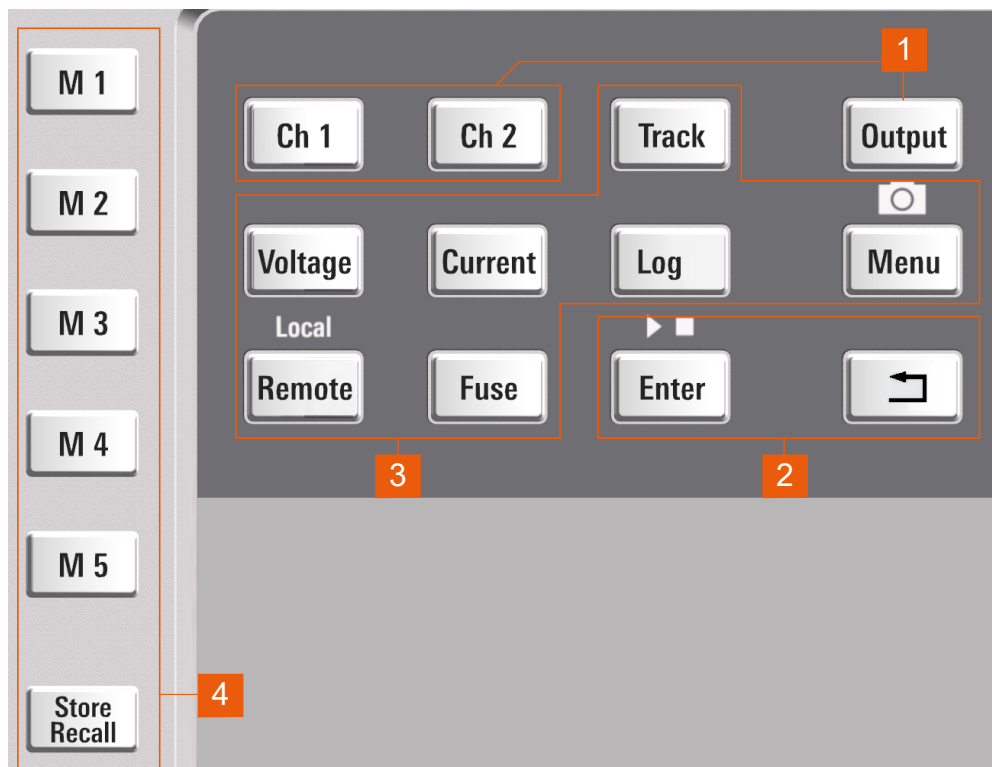
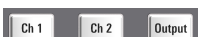

Figure 6-1: Function keys of R&S NGA100

- 1 = Output and channel controls
- 2 = Navigation keys
- 3 = Instrument functions
- 4 = Memory functions

6.1.1.1 Output and channel controls



These keys control the channel output settings of the instrument.

[Ch 1] / [Ch 2]

Selects the respective channel for output.

Applicable only for the two-channel models.

See [Chapter 7.1, "Setting the voltage and current"](#), on page 52.

Remote command:

`INSTRument:NSElect` on page 110

`INSTRument[:SElect]` on page 110

[Output]

The [Output] key controls the channel output settings of the instrument.

It is the master output switch which turns on or off the channel output.

See [Chapter 5.3.3, "Activating the channel output"](#), on page 33.

Remote command:



`OUTPut:GENeral` on page 117

`OUTPut[:STATe]` on page 116

`OUTPut:SElect` on page 118

6.1.1.2 Navigation keys

These keys provide navigation control in the instrument.

[Enter] 	44
[Back] 	44

[Enter] 

Confirms menu selection or entry in dialog boxes.

It also starts or stops (long press) the EasyArb function. See [Chapter 7.11.1, "Easy-Arb"](#), on page 72.

[Back] 

Returns to the previous menu level or exit the menu mode.

In menu dialog, press the [Back] key to discard changes and restore the previous value.

In channel display area, press the [Back] key to exit editing mode and keep the changes made.

Long press on the [Back] key to reset the historical channel information. See ["Historical channel information"](#) on page 37.

6.1.1.3 Instrument functions

These keys control the channel output settings and instrument functions.

[Voltage]	45
[Current]	45
[Track]	45
[Log]	45

[Menu].....	45
[Remote].....	45
[Fuse].....	45

[Voltage]

Sets the output voltage for the channel. See [Chapter 7.1, "Setting the voltage and current"](#), on page 52.

Remote command:

[\[SOURCE:\]VOLTage\[:LEVel\] \[:IMMediate\] \[:AMPLitude\]](#) on page 112

[APPLY](#) on page 114

[Current]

Sets the output current limit for the channel. See [Chapter 7.1, "Setting the voltage and current"](#), on page 52.

Remote command:

[\[SOURCE:\]CURRent\[:LEVel\] \[:IMMediate\] \[:AMPLitude\]](#) on page 113

[APPLY](#) on page 114

[Track]

Applicable only for the two-channel instrument models.

Configures the tracking function. See [Chapter 7.7, "Tracking function"](#), on page 62.

Remote command:

n.a.

[Log]

Toggles the data logging on/off. See [Chapter 7.10, "Data logging"](#), on page 69.

Remote command:

[LOG\[:STATe\]](#) on page 140

[Menu]

Main menu of the instrument. See [Chapter 6.1.3, "Menu key"](#), on page 47.

Long press on the [Menu] key to capture screenshot on the USB stick.

The default screenshot filename starts with a prefix `nga100_scr_` followed by an ascending index 000-999 (e.g. `nga100_scr_001.bmp`).

[Remote]

Long press on the [Remote] key to switch from remote to local control mode.

Remote command:

[SYSTEM:LOCaL](#) on page 106

[SYSTEM:REMote](#) on page 106

[SYSTEM:RWLock](#) on page 106

[Fuse]

Toggles the fuse on/off. See [Chapter 7.6.1, "Activating fuse"](#), on page 60.

Remote command:

[FUSE\[:STATe\]](#) on page 122

6.1.1.4 Memory functions

These keys are dedicated for a specific preprogrammed function.

[M1] / [M2] / [M3] / [M4] / [M5].....	46
[Store Recall].....	46

[M1] / [M2] / [M3] / [M4] / [M5]

Five memory keys to save or recall instrument settings.

Remote command:

*SAV on page 105

*RCL on page 105

[Store Recall]

Saves/loads instrument settings.

See [Chapter 7.12, "Store and recall"](#), on page 76.

Remote command:

*SAV on page 105

*RCL on page 105

6.1.2 Navigation controls

Navigation and value settings are done via the rotary knob and arrow keys.

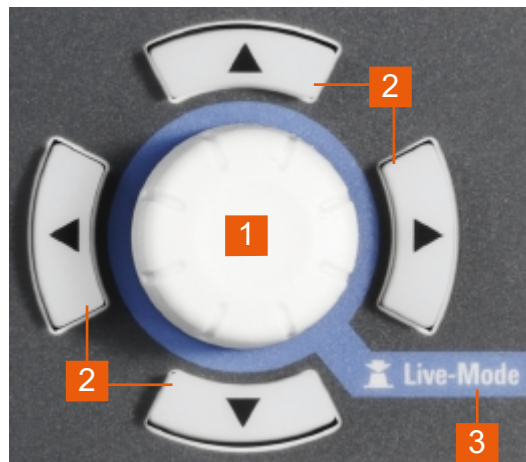

Figure 6-2: Navigation control

1 = Rotary knob

2 = Arrow keys

3 = Live-mode

For more information on how to navigate menus, dialogs and data entry in the instrument, see [Chapter 5.4.2.2, "Accessing the functionality"](#), on page 40 and [Chapter 5.4.2.3, "Entering data"](#), on page 40.

To go into live-mode of the instrument, see "To go into live-mode" on page 40.

6.1.3 Menu key

The R&S NGA100 [Menu] key provides access to instrument's functions and general instrumental settings. You can also obtain the instrument and service information via the [Menu] key.

Access:

1. Press [Menu] key on the front panel. The main menu screen appears.

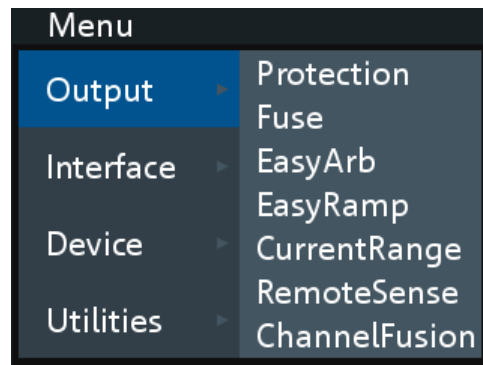



Figure 6-3: Main menu

2. Navigate the menu via the rotary knob or arrow keys.
3. Press the rotary knob or [Enter] key to enter the submenu.
4. Press  key to return to the previous menu level or exit the menu mode if it is already at the main menu level. Alternatively, press [Menu] key to exit the menu mode from any menu level.

Output.....	48
L Protection.....	48
L Fuse.....	48
L EasyArb.....	48
L EasyRamp.....	48
L CurrentRange.....	48
L RemoteSense.....	48
L ChannelFusion.....	48
Interface.....	48
L Ethernet.....	48
L WLAN.....	48
L Digital IO.....	49
L USB.....	49
Device.....	49
L Information.....	49
L General.....	49
L License.....	49

L Reset.....	49
Utilities.....	49
L System Test.....	49
L Update.....	49
L Service.....	49
L Date Time.....	49
L Help.....	49

Output

Provides menu items related to the instrument's output functions.

Protection ← Output

Configures the OVP and OPP protection settings for the instrument. See [Chapter 7.8, "Protection"](#), on page 63.

Fuse ← Output

Configures the fuse delay and fuse linking function of the channel. See [Chapter 7.6.2, "Fuse delay, fuse linking"](#), on page 61.

EasyArb ← Output

Programs the waveform of the instrument voltage and current settings. See [Chapter 7.11.1, "EasyArb"](#), on page 72.

EasyRamp ← Output

Configures the ramping time of the voltage for selected channel. See [Chapter 7.11.2, "EasyRamp"](#), on page 74.

CurrentRange ← Output

Configures the current range used for readback measurement. See [Chapter 7.3, "Current range"](#), on page 54.

RemoteSense ← Output

Configures the voltage compensation on cables connected to the load. See [Chapter 7.4, "Remote sense function"](#), on page 57.

ChannelFusion ← Output

Configures the channel fusion mode. See [Chapter 7.5, "Channel fusion"](#), on page 58.

Interface

Provides menu items related to connection setup.

Ethernet ← Interface

Configures the Ethernet interface. See [Figure 7-25](#).

WLAN ← Interface

Configures the WLAN interface. See [Figure 7-26](#).

The WLAN option R&S NGA100-K102 must be installed for this function to be available in the instrument.

Available only with instrument serial number below 110000.

Digital IO ← Interface

Configures the digital trigger I/O settings. See [Figure 7-16](#).

The digital trigger I/O option R&S NGA100-K103 must be installed for this function to be available in the instrument.

USB ← Interface

Configures the USB connection. See [Figure 7-28](#).

Requires restart of the instrument to apply the setting.

Device

Provides menu items related to the instrument's general settings, reset function and information about the instrument.

Information ← Device

Displays instrument information. See [Chapter 7.14.1, "Instrument information"](#), on page 90.

General ← Device

Configures general instrument settings. [Chapter 7.14.2, "General instrument settings"](#), on page 92.

License ← Device

Displays license information and install license options. See [Chapter 7.14.3, "License management"](#), on page 93.

Reset ← Device

Resets instrument to factory default settings. See [Chapter 7.14.4, "Reset instrument"](#), on page 95.

Utilities

Provides menu items such as system test, firmware update function and information for service.

System Test ← Utilities

Provides self-test function for display screen, keypad backlight, beeper and fan. See [Chapter 7.14.5, "System test"](#), on page 96.

Update ← Utilities

Performs firmware update on the instrument. See [Chapter 7.14.6, "Updating the firmware"](#), on page 97.

Service ← Utilities

This function is restricted for service personnel only.

Date Time ← Utilities

Configures system date and time. See [Chapter 7.14.8, "Date time"](#), on page 99.

Help ← Utilities

Provides help information for the instrument. See [Chapter 7.14.7, "Help"](#), on page 99.

6.2 Power derating

The R&S NGA100 power supply series provides a maximum output power of 40 W for a single channel model. Depending on the power supply models, up to 80 W of output power is provided for models with two identical channels with a continuous voltage range of 0 V to 35 V or 0 V to 100 V.

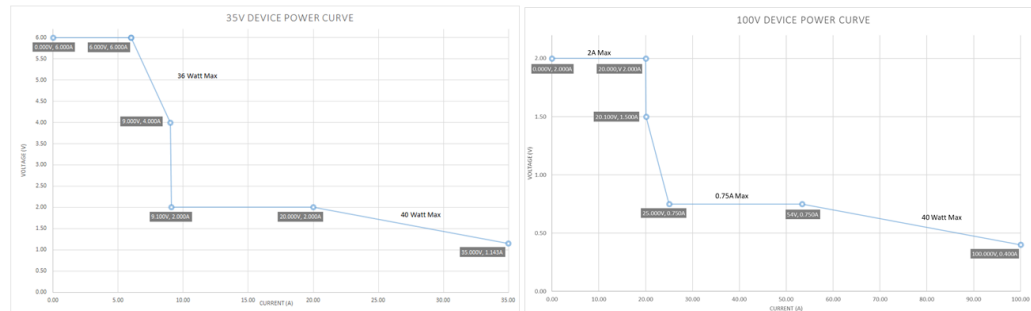

Figure 6-4: Output performance graph

According to the basic electrical formula for power (P) = current (I) x voltage (V), the following results for the maximum power per channel:

- NGA101, NGA141: 40.0 W for single channel
- NGA102, NGA142: 40.0 W per channel (80 W max for the combination of two channels)

For more information on the combination of channels, see [Chapter 12.1, "Parallel and series mode"](#), on page 148.

6.3 Operation modes

The R&S NGA100 operates in two different modes, i.e. CV and CC. The instrument switches automatically between CV and CC depending on the connected load.

CV mode

Figure 6-5 shows that if the instrument is in the range of voltage regulation, the output voltage V_{out} remains constant while the current may increase to its maximum value I_{max} when the connected load is increasing. In CV mode, the font text in the channel display area changes to green.

See ["Operating mode"](#) on page 38.

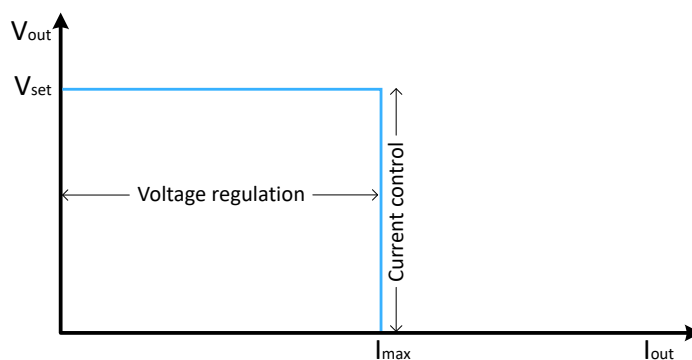

Figure 6-5: Current limit

CC mode

The current I_{max} corresponds to the current setting adjustable in the instrument.

If I_{out} reaches I_{max} , the instrument switches to CC mode, i.e. the output current remains constant and limited to I_{max} even if the load increases. Instead, the output voltage V_{out} decreases below V_{set} . In a short circuit, the output voltage drops towards zero. In CC mode, the font text in the channel display area changes to red.

See ["Operating mode"](#) on page 38.

7 Instrument functions

7.1 Setting the voltage and current

The R&S NGA100 comes with the following instrument models:

Depending on models, toggle the respective channel key ([Ch 1] or [Ch 2]) on the front panel to select these channels. When a channel is selected, the respective channel key illuminates. See [Figure 7-1](#).



Figure 7-1: Ch 1 key illuminates when selected



Voltage, current settings

If "Arbitrary" function of a Ch 1 is enabled, the channel voltage or current setting is disabled. See ["EasyArb function"](#) on page 72.

Depending on the instrument models, the R&S NGA100 adjusts the voltage and current values with the following step size. See [Table 7-1](#).

Table 7-1: Voltage, current step size

NGA101, NGA102	NGA141, NGA142
1 mV	10 mV
1 mA	1 mA

The setting of current value corresponds to the I_{\max} of the respective channel. It is advisable to set the current limit before operating the instrument to prevent damage to the load and instrument in the case of malfunction like short-circuit.

Access:

1. Press [Voltage] or [Current] key.
The previous set channel is selected.
The channel font changes to blue and all the navigation controls illuminate.
Selected [Voltage] or [Current] key and the channel key are also illuminated.
2. Press the desired channel key to switch to that channel.
Selected channel key ([Ch 1], [Ch 2]) illuminates.
3. Enter the desired voltage or current value.
4. Press the rotary knob, [Voltage] / [Current] or [Enter] key to confirm the value.
For more information on the operation modes, see [Chapter 6.3, "Operation modes"](#), on page 50.



Figure 7-2: Voltage and current settings in the instrument

See ["To go into live-mode"](#) on page 40 for alternative way to configure the voltage and current values.

See also ["Keypad"](#) on page 92 for setting the keypad fallback time.

Set output voltage and current

See details in ["\[Voltage\]"](#) on page 45 and ["\[Current\]"](#) on page 45.

Remote command:

[\[SOURCE:\]VOLTage\[:LEVel\] \[:IMMediate\] \[:AMPLitude\]](#) on page 112

[\[SOURCE:\]CURRent\[:LEVel\] \[:IMMediate\] \[:AMPLitude\]](#) on page 113

[APPLY](#) on page 114

7.2 Activating the channel output

Depending on the instrument models, the outputs of the channels (Ch 1, Ch 2) can be switched on or off by toggling the [Output] key on the front panel.

By default, the output is turned off when the instrument is switched on.

Access:

1. For two-channel models, press the required channel key.
Selected channel key ([Ch 1], [Ch 2]) illuminates.
2. Press [Output] key.
The R&S NGA100 outputs the set voltage on the channel.
Depending on the operating modes, the font text in the channel display area shows green in CV mode and red in CC mode.
See [Chapter 6.3, "Operation modes"](#), on page 50.
See also [Chapter 6.2, "Power derating"](#), on page 50.

Multiple outputs can be turned on or off at the same time. See more information in [Chapter 12, "Applications"](#), on page 148.



Figure 7-3: Output of Ch2 in CC mode

Activating the channel output

See details in "[Output]" on page 44.

Remote command:

[OUTPut:GENeral](#) on page 117

[OUTPut\[:STATE\]](#) on page 116

[OUTPut:SElect](#) on page 118

7.3 Current range

The "CurrentRange" dialog provides the configuration to set the measured output current range.

Access:

1. Press [Menu] key on the front panel.
The main menu screen appears.
2. Select "Output" > "CurrentRange" menu item to configure current range setting.
The R&S NGA100 displays the "CurrentRange" dialog.

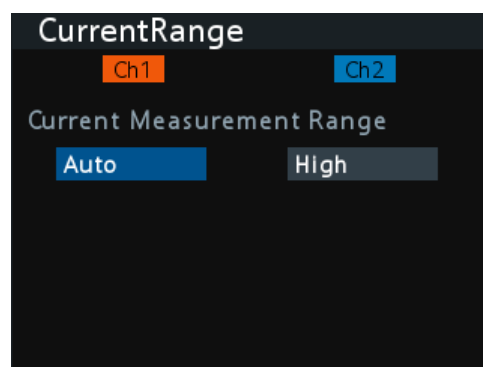

Figure 7-4: Current range dialog

Tip: "High" current readback range is tested for 100 μ A resolution per specification.

Note: To avoid oscillation in "Auto" mode, the "Low" range to "High" range switching point is at 205 mA and the "High" range to "Low" range switching point is at 195 mA.

3. Set the required current range for respective channel.

CurrentRange

Sets current range for selected channel.

Ch 1 / Ch 2 ← CurrentRange

Selected channel for current range function.

Remote command:

See "[Ch 1] / [Ch 2]" on page 44.

Current Measurement Range ← CurrentRange

Set the output current measurement range.

"High"	The measured output current is displayed in "A" with 10 μ A resolution.
"Low"	The measured output current is displayed in "mA" with 1 μ A resolution. The current setting is limited to 200mA, however if output current exceeds 205 mA (e.g. during a current spike), the "OVL" information is displayed.

"Auto" The measured output current is displayed in the following:

- "A" with 10 μ A resolution for current above 200 mA
- "mA" with 1 μ A resolution for current below 200 mA

Example:

The following shows the display of current range set to "High" for Ch 1 and "Low" for Ch 2.



Figure 7-5: Current display when current range set to High for Ch 1 and Low for Ch 2

If output current has exceeded 205 mA when current range is set "Low", the "OVLD" information is displayed.



Figure 7-6: Display of OVLD indicator when current > 205 mA at Ch 1

Remote command:

[SOURce:] CURRent: RANGe on page 114.

7.4 Remote sense function

The "Remote Sense" is a mechanism used to monitor and compensate the voltage drops on the cables connected to the load.

Once the remote sense is activated, it becomes part of the output feedback path for R&S NGA100. Disconnection or shorting of the remote sense lines causes a mismatch in the actual output voltage versus the reported value of the instrument. The error of differences is detected by the instrument and the output is turned off automatically with a corresponding error displayed to instruct the user to check on the connection.

Access:

1. Press [Menu] key.
2. Select "Output" > "Remote Sense" menu item to configure the remote sense mode. The R&S NGA100 displays the "RemoteSense" dialog.

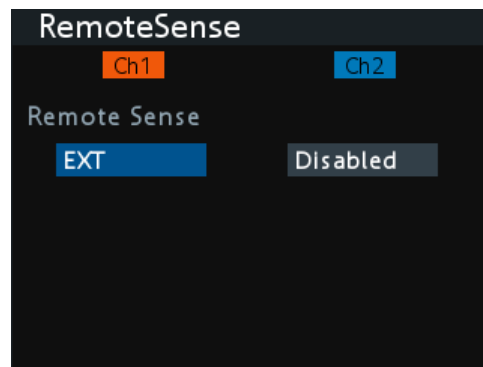

Figure 7-7: Remote sense dialog

3. Select the required remote sense mode for selected channels.

RemoteSense

Sets remote sense for selected channel.

Ch 1 / Ch 2 ← RemoteSense

Selected channel for remote sense function.

Remote command:

See "[Ch 1] / [Ch 2]" on page 44.

Remote Sense ← RemoteSense

Select the required remote sense mode.

"EXT" The internal voltage sense relay in the instrument is switched on and the connection of remote sense wires (S+, S-) to the input of the load become necessary. Failure to connect remote sense can cause over-voltage or unregulated voltage output from the R&S NGA100. The voltage sense relay remains switched on even when output is turned off.

"Disabled" Remote sense connection is disabled.

Remote command:

[SOURCE:] VOLTage:SENSe on page 111

7.5 Channel fusion

The "ChannelFusion" provides configuration to set the connection mode (series or parallel) of the device. The R&S NGA100 has an internal series link to connect Ch 1 and Ch 2 if series mode is configured.

The device operates as a 1-channel device which combines both Ch 1 and Ch 2 output.

For more information, see [Chapter 12.1, "Parallel and series mode"](#), on page 148.



The "ChannelFusion" is available only in the two-channel models.

1. Press [Menu] key on the front panel.
The main menu screen appears.
2. Select "Output" > "ChannelFusion" menu item to configure channel fusion mode.
The R&S NGA100 displays the "ChannelFusion" dialog.

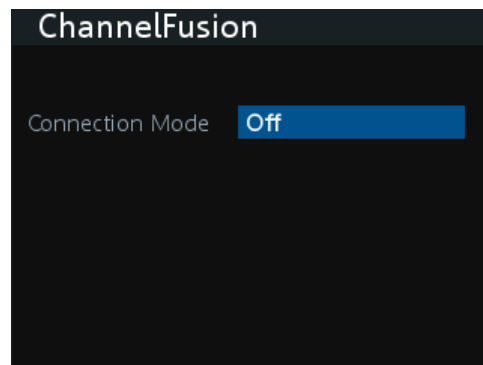

Figure 7-8: Channel fusion dialog

3. Set the required connection mode.

ChannelFusion

Sets channel fusion function.

Connection Mode ← ChannelFusion

Sets channel fusion connection mode.

- "Off" Channel operates separately.
- "Series" In series mode, the two terminals in the middle are used for output. There is an internal series link activated to connect channel 1 and channel 2 output. If this series mode is set, a "SER" indicator is displayed on the channel status bar. For details, see [Chapter 12.1.1, "Series mode"](#), on page 148.

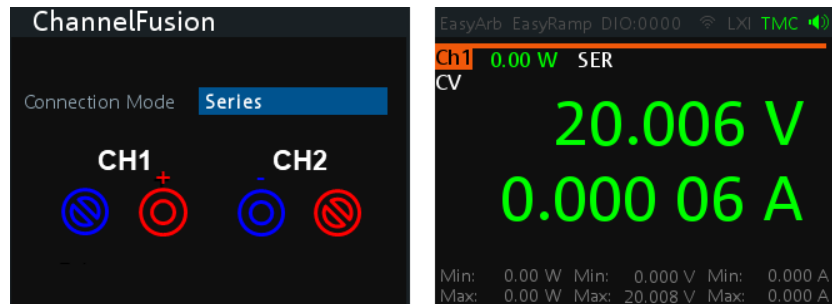

Figure 7-9: Series mode setting and output of one-channel display

Note: The "Digital IO", "EasyArb" and "EasyRamp" functions are disabled in this mode.

- "Parallel" In parallel mode, an external wire is required to connect the "CH1" and "CH2" terminals. All channels can be used as output. If parallel mode is set, a "PAR" indicator is displayed on the channel status bar. See ["Channel status"](#) on page 36.

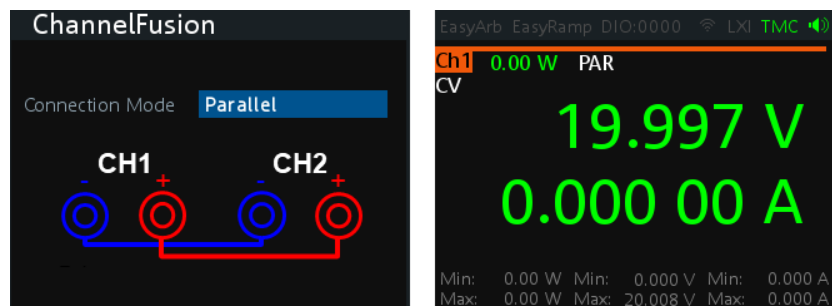

Figure 7-10: Parallel mode setting and output of one-channel display

See also [Chapter 12.1.2, "Parallel mode"](#), on page 149.

Note: The "Digital IO", "EasyArb", "EasyRamp" and "CurrentRange" functions are disabled in this mode.

Remote command:

`OUTPut:FUSion` on page 117

7.6 Electronic fuse

To protect a connected, sensitive output in general, the R&S NGA100 power supply includes an electronic fuse which can be switched on individually for each channel.

A fuse delay can be applied to each channel and individual electronic fuses can be logically linked to switch off the interlinked channels if a fuse triggers.

For more information, see [Chapter 7.6.2, "Fuse delay, fuse linking"](#), on page 61 for fuse delay and fuse linking configuration.

7.6.1 Activating fuse

The following shows the steps to activate the electronic fuse in the instrument.

Access:

1. Turn off the output before activating the fuse for each channel.
2. Press [Fuse] key.
The R&S NGA100 activates the fuse function and the [Fuse] key illuminates.
Activated fuses are also illuminated on channel keys for the two-channel models.
3. For the two-channel models, press the desired channel to activate or deactivate the fuse.
For the single-channel models, toggle the [FUSE] key to activate or deactivate the fuse.
Selected channel key ([Ch 1], [Ch 2]) illuminates.
On the channel display area, the "FUSE" is indicated on selected channels.
4. Repeat step 1 and step 2 to disable the fuse function.

[Fuse]

Activates fuse function.

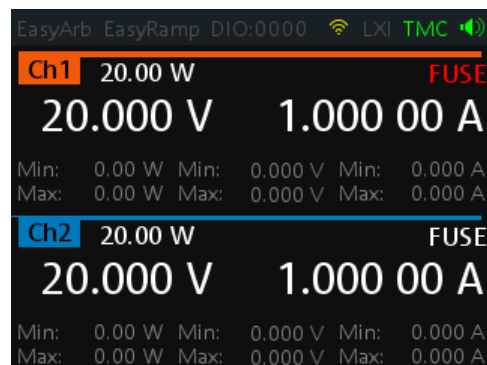

Figure 7-11: Fuse indicator on respective channel

Remote command:

[FUSE:TRIPped?](#) on page 122

[FUSE\[:STATE\]](#) on page 122

7.6.2 Fuse delay, fuse linking

The fuse delay and fuse linking functions provide the flexibility to handle a fuse tripped event when it occurs. When the current for a channel exceeds the value I_{\max} and the fuse tripped event triggered, the affected channels are turned off according to the settings configured in the fuse delay and fuse linking.

With fuse delay function, it allows you to ignore the current peaks set above the current limit that occurs during the time set in the fuse delay. This prevents the fuse to be triggered in case of a capacitive load.

With fuse linking function, it allows you to logically interlink channels with their electronic fuses. If a fuse trips during operation, all channels interlinked with this channel are turned off.

See [Chapter 7.6.1, "Activating fuse"](#), on page 60 for more information.

Access:

1. Press [Menu] key.
2. Select "Output" > "Fuse" menu item.
The R&S NGA100 displays the "Fuse" dialog. See [Figure 7-12](#).

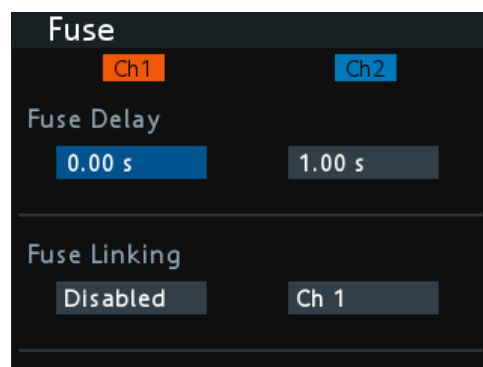

Figure 7-12: Fuse dialog

3. Set "Fuse Delay" to a desired value.
You can set a value from 0 s to 10 s in a 0.01 s step size.
4. Configure the "Fuse Linking" setting.
The R&S NGA100 provides the following options:
Example for "Ch 1", the available options are as follows:
 - "Ch 2": "Ch 2" is linked to "Ch 1". If "Ch 1" fuse tripped, "Ch 2" is turned off.
 - "Disabled": "Ch 1" is not linked to any other channels.

Fuse

Sets fuse delay and fuse linking function for selected channel.

Ch 1 / Ch 2 ← Fuse

Selected channel for fuse delay and fuse linking function.

Remote command:
See "[Ch 1] / [Ch 2]" on page 44.

Fuse Delay ← Fuse

Time taken before fuse tripped event occurs.

Remote command:
`FUSE:DELay` on page 121

Fuse Linking ← Fuse

Sets fuse linking for the previous selected channel.

"Ch 1"	"Ch 1" is linked to selected channel. If selected channel fuse tripped, "Ch 1" is turned off.
"Ch 2"	"Ch 2" is linked to selected channel. If selected channel fuse tripped, "Ch 2" is turned off.
"Disabled"	Selected channel is not linked to any other channels.

Remote command:
`FUSE:LINK` on page 121
`FUSE:UNLink` on page 122

7.7 Tracking function



Applicable only to R&S NGA102 and R&S NGA142 power supply models.

For power supplies with multiple channels, the channels can be linked such that changes made on the selected tracked channel are applied to other channels.

Access:

1. Press [Track] key.
The R&S NGA100 activates the tracking function and the [Track] key illuminates.
2. Press the channel keys of the channels to be tracked.
The selected tracked channel key ([Ch 1] or [Ch 2]) illuminates.
3. Press [Current] or [Voltage] key if current or voltage values should be tracked.
All the channels are highlighted in blue and all the navigation controls illuminate. Selected [Voltage] or [Current] key is also illuminated.
4. Set the desired voltage or current value.
Use the arrow keys or rotary knob to enter the value. All tracked channels voltage or current are changed by the same amount.



Figure 7-13: Tracking dialog

[Track]

Activates tracking function.

Remote command:

n.a.

7.8 Protection

The R&S NGA100 provides individual overvoltage protection (OVP) and overpower protection (OPP) settings for each channel. With both functions activated, the R&S NGA100 protects itself and the load in case of voltage or power overloads.

If protection is tripped, a red flashing OVP or OPP indicator is displayed on the respective channel. See [Figure 7-14](#).

A beep is sounded if buzzer is enabled. See [Figure 7-33](#).



Figure 7-14: Indicator of OVP/OPP when tripped

Access:

1. Press [Menu] key.
2. Select "Output" > "Protection" menu item.
The R&S NGA100 displays the "Protection" dialog. See [Figure 7-15](#).

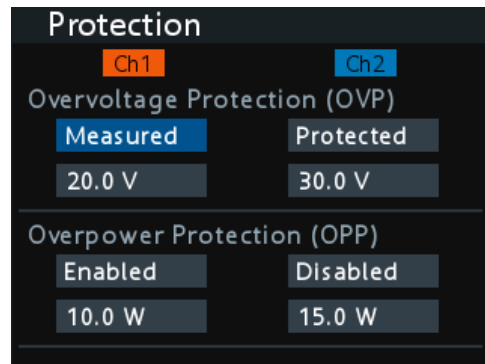

Figure 7-15: Protection dialog

- Set the desired mode and voltage for OVP protection.
The R&S NGA100 turns off the output channel when the measured voltage exceeded the preset value.
- Set the desired mode and power for OPP protection.
The R&S NGA100 turns off the output channel when the measured power exceeded the preset value.

Protection

Sets overvoltage and overpower protection for selected channel.

Ch 1 / Ch 2 ← Protection

Selected channel for overvoltage and overpower protection function.

Remote command:

See "[Ch 1] / [Ch 2]" on page 44.

Overvoltage Protection (OVP) ← Protection

Sets OVP mode and level for overvoltage protection.

Remote command:

[SOURCE:]VOLTage:PROTection[:STATe] on page 125

[SOURCE:]VOLTage:PROTection:TRIPped? on page 125

[SOURCE:]VOLTage:PROTection:CLEar on page 126

<Mode> ← Overvoltage Protection (OVP) ← Protection

Sets OVP protection mode.

"Measured" If the measured value exceeds the set limit, the output is switched off. Switching on the channels triggered the OVP if the condition remains.

"Protected" If the setting exceeds the set limit, the output is disabled.

"Disabled" OVP is set to maximum value supported by hardware. See the R&S NGA100 brochure for the instrument specification.

Remote command:

[SOURCE:]VOLTage:PROTection:MODE on page 125

<Level> ← Overvoltage Protection (OVP) ← Protection

Sets OVP voltage level.

The R&S NGA100 turns off the respective channel when the measured voltage exceeded the preset value.

Remote command:

[\[SOURCE:\]VOLTage:PROTection:LEVel](#) on page 126

Overpower Protection (OPP) ← Protection

Sets OPP mode and level for overpower protection.

Remote command:

[\[SOURCE:\]POWer:PROTection:TRIPped?](#) on page 128

[\[SOURCE:\]POWer:PROTection:CLEar](#) on page 129

<Mode> ← Overpower Protection (OPP) ← Protection

Sets OPP protection mode.

"Enabled" The channel is turned off if the measured power exceeds OPP value.

"Disabled" Depending on models, output power is limited to maximum value of 40 W (R&S NGA101, R&S NGA102) or 80 W (R&S NGA141, R&S NGA142).

Remote command:

[\[SOURCE:\]POWer:PROTection\[:STATe\]](#) on page 128

<Level> ← Overpower Protection (OPP) ← Protection

Sets OPP power level.

The R&S NGA100 turns off the respective channel when the measured power exceeded the preset value.

Remote command:

[\[SOURCE:\]POWer:PROTection:LEVel](#) on page 127

7.9 Digital trigger I/O

CAUTION

Digital I/O Pins Voltage Rating

Do not exceed the maximum voltage rating of the digital I/O pins (5.25 V max) when supplying voltages to the pins.



R&S NGA-K103 (order number: 5601.8425.99) option is required for the digital trigger I/O.

The four data lines of the digital I/O interface are mutually independent and can be used as trigger input or trigger output separately. See [Figure 5-4](#).

- **Trigger input**
The data lines of the digital I/O interface receive external trigger signal. The external trigger signal triggers the selected channel (Ch 1, Ch 2) with the set response when the trigger condition ("Active High" or "Active Low") is met.
- **Trigger output**
The data lines of the digital I/O interface output an "Active Low" or "Active High" signal when the trigger condition of the selected channel is met.

Table 7-2: Trigger in parameters and conditions

Trigger in parameters	Trigger conditions		Description
Channel	"Ch 1", "Ch 2"		Target output channel selected for trigger response.
Response Trigger	Output On	Level	Selected channel [Output] is enabled when the selected logic level is met.
	Output Off	Level	Selected channel [Output] is disabled when the selected logic level is met.
	Output Toggle	Pulse	Selected channel [Output] is toggled when the selected logic pulse is met.
	Output Inhibit	Level	Selected channel [Output] is inhibited when the selected logic level is met. When the selected channel [Output] is put to inhibit state, manual or remote operation on selected channel [Output] is no longer possible. To reverse the inhibit state, remove the source of the trigger signal. You can either disable the affected DIO interface or remove the source from the affected DIO interface at the rear panel.
	Start EasyArb (Only for Ch 1)	Level	Activates the EasyArb function on channel 1 when the selected logic level is met. The EasyArb is deactivated when the level changes (i.e from active high to active low) See Chapter 7.11.1, "EasyArb" , on page 72.
Pulse		Activates the EasyArb function on channel 1 when the selected pulse is met. See Chapter 7.11.1, "EasyArb" , on page 72.	
Logic	"Active High"		Set the logic level of the trigger in signal.
	"Active Low"		

Table 7-3: Trigger out parameters and conditions

Trigger out parameters	Trigger conditions		Description
Channel	"Ch 1", "Ch 2"		Output channel selected to monitor for trigger condition.
Condition Trigger	Output On		Output the selected logic level when the [Output] is turned on at the selected channel.

Trigger out parameters	Trigger conditions		Description
	Output Off		Output the selected logic level when the [Output] is turned off at the selected channel.
	Fuse Tripped		Output the selected logic level when a fuse tripped event occurs on the selected channel. See Chapter 7.6, "Electronic fuse" , on page 60.
	CC Mode		Output the selected logic level when the selected channel operates in the CC mode. See "CC mode" on page 51.
	Voltage Level	>= "set value"	Output the selected logic level when the voltage level of the selected channel is greater or equal to the set level.
	Current Level	>= "set value"	Output the selected logic level when the current level of the selected channel is greater or equal to the set level.
	Critical Event	"OVP"	Output the selected logic level when the selected critical event (OVP, OPP, OTP) occurs on the selected channel. See Chapter 7.8, "Protection" , on page 63.
		"OPP"	
		"OTP"	
	EasyArb Active		Output the selected logic level when the EasyArb function is running on channel 1. See Chapter 7.11.1, "EasyArb" , on page 72. Note: For a reliable DIO trigger output, the EasyArb waveform needs to be at least 200 ms.
Logic	"Active High"		Set the logic level of the trigger out signal.
	"Active Low"		



After a recall function, the "Master Enable" is disabled. See ["Recall instrument settings"](#) on page 77.



Enable the required DIO and "Master Enable" parameters to set up the digital IO for usage.

Access:

1. Press [Menu] key.
2. Select "Interface" > "Digital IO" menu item.
The R&S NGA100 displays the "Digital IO" dialog. See [Figure 7-16](#).

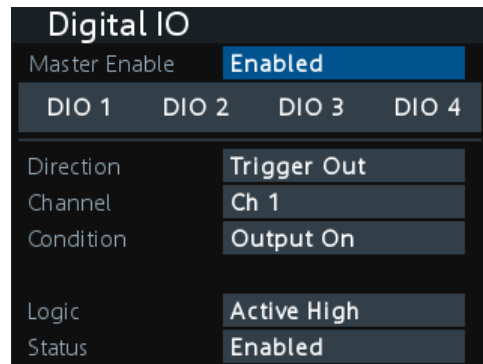

Figure 7-16: Digital IO dialog

3. Select the desired DIO interface for configuration.
For configuration details, see "Digital IO" on page 68.

Digital IO.....	68
L Master Enable.....	68
L DIO 1 / DIO 2 / DIO 3 / DIO 4.....	68
L Direction.....	68
L Channel.....	69
L Condition.....	69
L Logic.....	69
L Status.....	69

Digital IO

Settings for digital IO interface.

Master Enable ← Digital IO

Master control for all the digital IO interfaces. The state is disabled when any settings are changed in the digital IO settings. Thus it is required to set it when all settings are configured.

"Enabled" "Master Enable" state is activated for all digital IO interfaces.

"Disabled" "Master Enable" state is deactivated for all digital IO interfaces.

Remote command:

`TRIGger:MASTer[:STATe]` on page 137

DIO 1 / DIO 2 / DIO 3 / DIO 4 ← Digital IO

Sets the selected digital I/O line settings.

Direction ← DIO 1 / DIO 2 / DIO 3 / DIO 4 ← Digital IO

Sets trigger direction for the specified digital I/O line.

"Trigger Out" Output trigger signal.

"Trigger In" Accept external trigger signal.

Remote command:

`TRIGger:DIRection:DIO<IO>` on page 134

Channel ← DIO 1 / DIO 2 / DIO 3 / DIO 4 ← Digital IO

Sets channel for DIO settings.

Remote command:

`TRIGger:IN:SOURce:DIO<IO>` on page 136

`TRIGger:OUT:SOURce:DIO<IO>` on page 138

Condition ← DIO 1 / DIO 2 / DIO 3 / DIO 4 ← Digital IO

Sets trigger condition for the selected digital I/O line.

See [Table 7-2](#) and [Table 7-3](#) for the list of trigger conditions.

Remote command:

`TRIGger:IN:ARBitrary:DIO<IO>` on page 135

`TRIGger:IN:RESPonse:DIO<IO>` on page 135

`TRIGger:OUT:CONDition:DIO<IO>` on page 137

`TRIGger:OUT:CRITevent:DIO<IO>` on page 138

`TRIGger:OUT:CURRlevel:DIO<IO>` on page 138

`TRIGger:OUT:VOLTlevel:DIO<IO>` on page 139

Logic ← DIO 1 / DIO 2 / DIO 3 / DIO 4 ← Digital IO

Sets trigger logic of the selected digital I/O line.

"Active High" Trigger logic is set to active high for the selected digital I/O line.

"Active Low" Trigger logic is set to active low for the selected digital I/O line.

Remote command:

`TRIGger:LOGic:DIO<IO>` on page 136

Status ← DIO 1 / DIO 2 / DIO 3 / DIO 4 ← Digital IO

Sets the state of the specified digital I/O line.

The state is disabled when any settings are changed.

"Enabled" Enabled the selected DIO interface and monitor or feedback the trigger condition on the selected channel.

"Disabled" Disabled the selected DIO interface state.

Remote command:

`TRIGger[:ENABle]:DIO<IO>` on page 135

7.10 Data logging

The data logging function provides the logging of data to external USB storage.

Access:

1. Attached a USB storage to the USB connector on the front panel.
2. Press [Log] key on the front panel.
The R&S NGA100 starts the data logging.
An indicator "Logging started" is displayed on the status bar, the [Log] key is also illuminated when data logging starts.

The data is stored in the file named `log-yyyyMMddTHHmss.csv`, e.g. `log-19701231T235501.csv`. See [Figure 7-19](#).

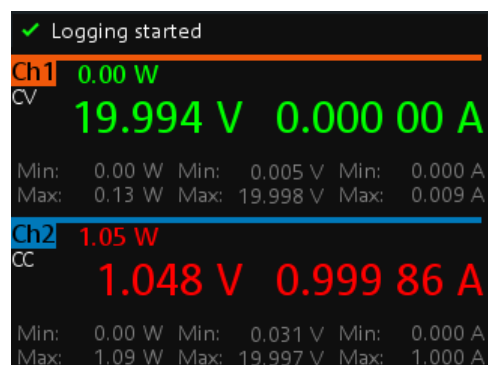

Figure 7-17: Logging started

3. Toggle the [Log] key to stop data logging.
The R&S NGA100 finishes the data logging.
An indicator "Finish writing to usb" is displayed on the status bar.



Figure 7-18: Finish writing to USB

#Device	NGA142					
#Device Name	rs-instrument.local					
#Format	LOG					
#Date	2023-01-14					
#Version	4.008 00937EBC3					
#Logging Interval[s]	0.1					
Timestamp	U1[V]	I1[A]	P1[W]	U2[V]	I2[A]	P2[W]
30:00.2	0	0	0	0.001	0	0
30:00.3	0	0	0	0.001	0	0
30:00.4	0	0	0	0.001	0	0
30:00.5	0	0	0	0.001	0	0
30:00.6	0	0	0	0.001	0	0
30:00.7	0	0	0	0.001	0	0
30:00.8	0	0	0	0.001	0	0
30:00.9	0	0	0	0.001	0	0
30:01.0	0	0	0	0.001	0	0
30:01.1	0	0	0	0.001	0	0
30:01.2	0	0	0	0.001	0	0
30:01.3	0	0	0	0.001	0	0
30:01.4	0	0	0	0.001	0	0
30:01.5	0	0	0	0.001	0	0
30:01.6	0	0	0	0.001	0	0
30:01.7	0	0	0	0.001	0	0
30:01.8	0	0	0	0.001	0	0
30:01.9	0	0	0	0.001	0	0
30:02.0	0	0	0	0.001	0	0
30:02.1	0	0	0	0.001	0	0
30:02.2	0	0	0	0.001	0	0
30:02.3	0	0	0	0.001	0	0
30:02.4	0	0	0	0.001	0	0
30:02.5	0	0	0	0.001	0	0
30:02.6	0	0	0	0.001	0	0

Figure 7-19: Log data sample

[Log]

Toggles on/off data logging.

Remote command:

[LOG\[:STATE\]](#) on page 140

[DATA:DATA?](#) on page 140

[DATA:LIST?](#) on page 141

7.11 Advanced functions

The following chapters provide information about the [EasyArb](#) and [EasyRamp](#) menu items found in the [Menu] key.

Access:

1. Press [Menu] key.
2. Select the "Output" menu item.

The R&S NGA100 displays the respective menu item dialog.

7.11.1 EasyArb



EasyArb function

The arbitrary function is available only in Ch 1.
See "[Voltage, current settings](#)" on page 52.



LabVIEW driver

The arbitrary functions in LabVIEW driver rshmc804x do not support the EasyArb feature in the R&S NGA100.

The R&S NGA100 series allows you to generate freely programmable waveforms which can be reproduced within the limits set by the instrument for voltage and current of the respective channel. To configure a waveform, you can use the control panel or an externally created waveform, see "[HMExplorer](#)" on page 85.

Access:

1. Select "EasyArb" menu item.

The R&S NGA100 displays the "EasyArb" dialog. See [Figure 7-20](#).

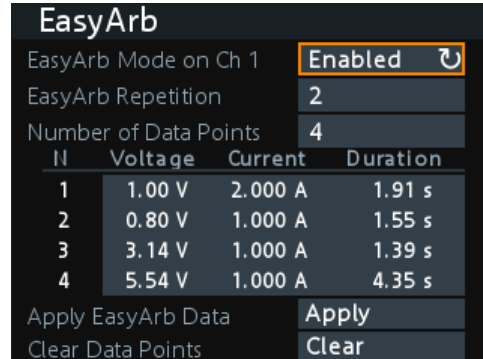

Figure 7-20: EasyArb dialog

2. Set the desired EasyArb settings to generate the waveform.
For details, see "[EasyArb](#)" on page 73
3. Press [Menu] key to return to the [Channel display area](#).
The [Enter] key is illuminated.
4. Press [Output] key to enable the R&S NGA100 output.
5. Press [Enter] key to start the EasyArb function.
6. Long press on the [Enter] key to stop the EasyArb function.

[EasyArb](#).....73

L EasyArb Mode on Ch 1.....	73
L EasyArb Repetition.....	73
L Number of Data Points.....	73
L EasyArb List table.....	73
L N.....	73
L Voltage.....	73
L Current.....	74
L Duration.....	74
L Apply EasyArb Data.....	74
L Clear Data Points.....	74

EasyArb

Settings for EasyArb waveform generator.

EasyArb Mode on Ch 1 ← EasyArb

Sets EasyArb mode on the output channel.

"Enabled" Enable the EasyArb function on the output channel.

"Disabled" Disable the EasyArb function on the output channel. The corresponding output channel is also disabled.

Remote command:

[ARbitrary\[:STATe\]](#) on page 133

EasyArb Repetition ← EasyArb

Sets the number of times the waveform is output in the EasyArb table. If this is set to "0", the waveform is output continuously.

Remote command:

[ARbitrary:REPetitions](#) on page 132

Number of Data Points ← EasyArb

Sets the number of data points in the EasyArb table. Each data point contains the settings for "Voltage", "Current" and "Duration".

Remote command:

[ARbitrary:POINTs?](#) on page 133

EasyArb List table ← EasyArb

Configures the EasyArb data table. Use the arrow keys on the [navigation control](#) to navigate the "Voltage", "Current" and "Duration" settings.

N ← EasyArb List table ← EasyArb

Indexing of the table list.

Remote command:

[ARbitrary:DATA](#) on page 132

Voltage ← EasyArb List table ← EasyArb

Sets the voltage level for the EasyArb point.

Remote command:

[ARbitrary:DATA](#) on page 132

Current ← EasyArb List table ← EasyArb

Sets the current level for the EasyArb point.

Remote command:

[ARbitrary:DATA](#) on page 132

Duration ← EasyArb List table ← EasyArb

Sets the duration taken between two data points.

Remote command:

[ARbitrary:DATA](#) on page 132

Apply EasyArb Data ← EasyArb

Saves EasyArb configuration.

The EasyArb data points are sent to Ch 1.

Remote command:

[ARbitrary:DATA](#) on page 132

[ARbitrary:START](#) on page 133

[ARbitrary:STOP](#) on page 133

Clear Data Points ← EasyArb

Reset all the data points in the EasyArb table to default values for [Voltage](#), [Current](#) and [Duration](#) respectively.

Remote command:

[ARbitrary:CLEAr](#) on page 131

7.11.2 EasyRamp

With EasyRamp, the R&S NGA100 provides you the operating condition to output a constant rise of the supply voltage. The output voltage can be increased continuously within a 10 ms to 10 s timeframe. See [Figure 7-21](#).

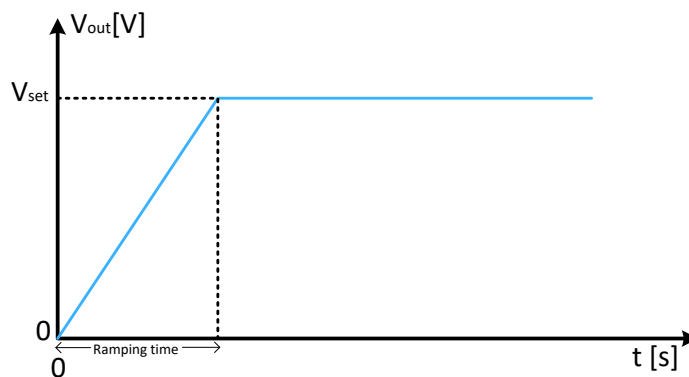

Figure 7-21: Ramping voltage output

Access:

1. Select "EasyRamp" menu item.
The R&S NGA100 displays the "EasyRamp" dialog. See [Figure 7-22](#).

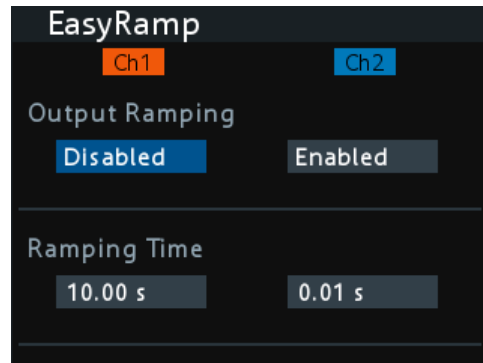

Figure 7-22: EasyRamp dialog

2. Set the desired EasyRamp settings.
For details, see "EasyRamp" on page 75.
3. Press [Enter] key to confirm the settings.

EasyRamp.....	75
L Ch 1 / Ch 2.....	75
L Output Ramping.....	75
L Ramping Time.....	75

EasyRamp

Settings for EasyRamp function.

Ch 1 / Ch 2 ← EasyRamp

Selected channel for EasyRamp function.

Remote command:

See "[Ch 1] / [Ch 2]" on page 44.

Output Ramping ← EasyRamp

Sets output ramping mode.

"Enabled" EasyRamp function is activated.

"Disabled" EasyRamp function is deactivated. The output channel state is also disabled.

Remote command:

[SOURce:]VOLTage:RAMP[:STATe] on page 134

Ramping Time ← EasyRamp

Duration taken for the voltage to rise to V_{set} .

Remote command:

[SOURce:]VOLTage:RAMP:DURation on page 134

7.12 Store and recall



The [Store Recall] function is disabled when the instrument is in editing mode. See "[Operating mode](#)" on page 38.



Upon power-up, the instrument loads the last stored settings from internal memory location. The R&S NGA100 output state of all channels (Ch 1, Ch 2) is disabled when the recall function is activated.



Autosave instrument settings

Auto save of instrument settings is applied when any of the following parameters is changed (including parameters from instrument settings):

- [General instrument settings](#)
- [USB connection mode](#)
- [WLAN settings](#) (only with instrument serial number below 110000)
 - "Module"
 - "SSID"
 - "Password"
- [Ethernet settings](#)

Instrument settings

The instrument settings can be stored or recalled from memory locations M1 to M5.

The following instrument settings are stored or recalled in the memory location:

- [Fuse settings](#)
- [Protection settings](#)
- [EasyRamp settings](#)
- [Set voltage and current levels](#)
- [Remote sense settings](#)
- [Current range settings](#)
- ¹ [Channel fusion settings](#)
- ² [EasyArb settings](#)
- ² [Digital IO settings](#)

¹ The channel fusion settings are not included in the autosave instrument settings. See "[Autosave instrument settings](#)" on page 76.

² The EasyArb or DIO settings are not included in the autosave instrument settings and can only be saved in the respective dialog environment and all other above instrument settings are not saved when a store function is made. Similarly, when a recall function is made on the same-stored memory location, only the EasyArb or DIO settings are recalled.

Store instrument settings

Access:

1. Long press [Store Recall] key to store instrument settings.
The R&S NGA100 displays a message "Store device settings: select any [Mx] key" in the status bar.

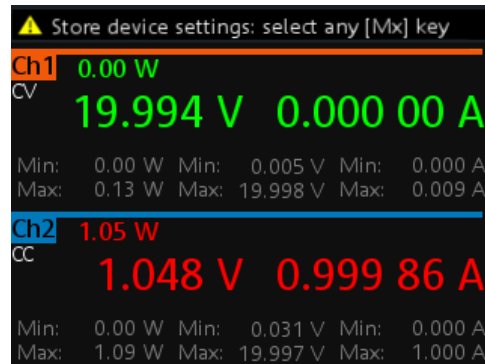

Figure 7-23: Store instrument settings

2. Press any of the memory keys ([M1], [M2], [M3], [M4], [M5]) to store the instrument settings.
The R&S NGA100 stores the instruments settings in the selected memory location.

Recall instrument settings

Access:

1. Press [Store Recall] key to recall instrument settings.
The R&S NGA100 displays a message "Recall device settings: select any [Mx] key" in the status bar.

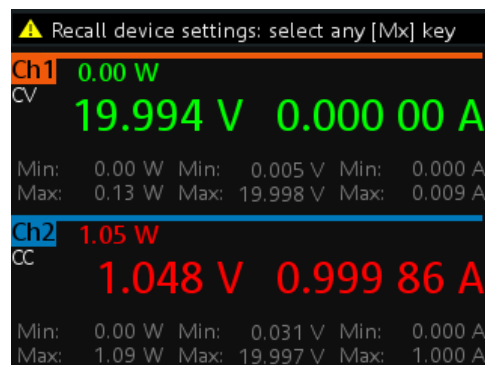

Figure 7-24: Recall instrument settings

2. Press any of the memory keys ([M1], [M2], [M3], [M4], [M5]) to recall the instrument settings.
The R&S NGA100 recalls the instruments settings from the selected memory location.

[Store Recall]

Saves/loads instrument settings.

In the EasyArb and DIO dialog environment, only the EasyArb or DIO settings are saved or loaded, the instrument settings are not saved or loaded. See "[Instrument settings](#)" on page 76.

Remote command:

*[SAV](#) on page 105

*[RCL](#) on page 105

[ARbitrary:SAV](#) on page 133

[ARbitrary:RCL](#) on page 132

[TRIGger:SAV](#) on page 139

[TRIGger:RCL](#) on page 139

7.13 Interfaces and protocols

There are various of ways how the R&S NGA100 can be remotely accessed and controlled.

Access:

1. Press [Menu] key.
2. Select "Interface" menu item to configure the required interface.
The R&S NGA100 displays the available interface options.

7.13.1 Network connection

To establish a local area network (LAN) connection with the R&S NGA100 for remote control operation.

- [LAN](#)
- [Wireless LAN](#)

7.13.1.1 LAN connection

The R&S NGA100 is equipped with a network interface and can be connected to an Ethernet LAN (local area network). A LAN connection is necessary for remote control of the instrument, and for access from a computer using a web browser.



To establish a network connection, connect a commercial RJ-45 cable to the LAN port of the instrument and to a PC or network switch.

Depending on the network capacities, the TCP/IP address information for the instrument can be obtained in different ways.

- If the network supports dynamic TCP/IP configuration using the dynamic host configuration protocol (DHCP), and a DHCP server is available, all address information can be assigned automatically.
- Otherwise, the address must be set manually. Automatic private IP addressing (APIPA) is not supported.

By default, the instrument is configured to use dynamic TCP/IP configuration and obtain all address information automatically. This means that it is safe to establish a physical connection to the LAN without any previous instrument configuration.

Access:

1. **NOTICE!** Risk of network failure. Before connecting the instrument to the network or configuring the network, consult your network administrator. Connection errors may affect the entire network.

If your network does not support DHCP, or if you choose to disable dynamic TCP/IP configuration, you must assign valid address information before connecting the instrument to the LAN. Contact your network administrator to obtain a valid IP address.

2. Connect a LAN cable to the [LAN port](#).
3. Configure the connection settings manually or have the network configure the settings for you via menu. By default, automatic configuration is set in the instrument. For manual configuration, select "Ethernet" menu item. The R&S NGA100 displays the Ethernet dialog.

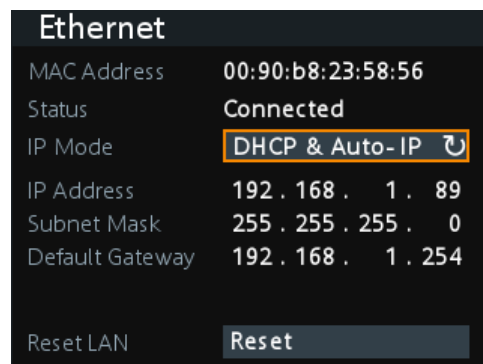

Figure 7-25: Ethernet dialog

4. Configure the required Ethernet settings. See details in "[Ethernet](#)" on page 80.
5. Select "Apply" to complete the configuration.
6. Press [Menu] key to exit the dialog.

Ethernet	80
L MAC Address	80
L Status	80
L IP Mode	80
L IP Address	80

L Subnet Mask.....	80
L Default Gateway.....	80
L Reset LAN.....	81
L Apply.....	81

Ethernet

Sets the Ethernet settings for LAN connection.

MAC Address ← Ethernet

Displays the MAC address of this instrument.

Remote command:

n.a.

Status ← Ethernet

Displays the LAN connection status.

"Connected" LAN connection is up.

"Disconnected" LAN connection is down.

Remote command:

[SYSTem:COMMunicate:SOCKet:DHCP\[:STATe\]](#) on page 107

IP Mode ← Ethernet

Sets IP mode for LAN connection.

"Static & Manual" Manually configure an IP address for the instrument.
ual"

"DHCP & Auto-IP" Automatically assign an IP address to the instrument.
IP"

Remote command:

[SYSTem:COMMunicate:SOCKet:DHCP\[:STATe\]](#) on page 107

IP Address ← Ethernet

Address used in communication with the network. This address is manually configured if "IP Mode" is set to "Static & Manual".

Remote command:

[SYSTem:COMMunicate:SOCKet:IPAddress?](#) on page 107

Subnet Mask ← Ethernet

Secondary address used in communication with the network. This address is manually configured if "IP Mode" is set to "Static & Manual".

Remote command:

n.a.

Default Gateway ← Ethernet

Gateway address to connect to the network. This address is manually configured if "IP Mode" is set to "Static & Manual".

Remote command:

n.a.

Reset LAN ← Ethernet

Restores the LAN settings to factory default.

It also removes the LXI web password.

Remote command:

n.a.

Apply ← Ethernet

Apply static IP settings.

Remote command:

n.a.

7.13.1.2 Wireless LAN connection**Wi-Fi transmitter performance**

Frequency range: 2412 MHz to 2484 MHz

18.9 dBm (802.11g, 6 Mbps)

**Instrument option**

R&S NGA-K102 (order number: 5601.8419.99) option is required to connect the R&S NGA100 to a network via WLAN connection.

Wireless LAN option is only available for instrument with serial number below 110000.

**WLAN connection**

The LAN connection has a higher priority over WLAN.

If LAN is connected, the WLAN connection will be disconnected. When LAN is disconnected, WLAN reconnects automatically.

An alternative to connection in local area network is wireless LAN connection. With the presence of an authenticated Wi-Fi signal, the R&S NGA100 automatically connects to a network and navigation can be made via the web browser according to the WLAN IEEE 802.11 b/g/n standards.

1. **WARNING!** Risk of RF exposure. This is a class A product. In a domestic environment, this product may cause radio interference in which case the user may be required to take adequate measures.
 - When WLAN is active, a minimum separation distance of 20 cm from front panel of the instrument must be observed at all times.
 - When WLAN is active, no operation of antenna or transmitter should be co-located with the instrument.
2. Select "WLAN" menu item.
The R&S NGA100 displays the "WLAN" dialog.

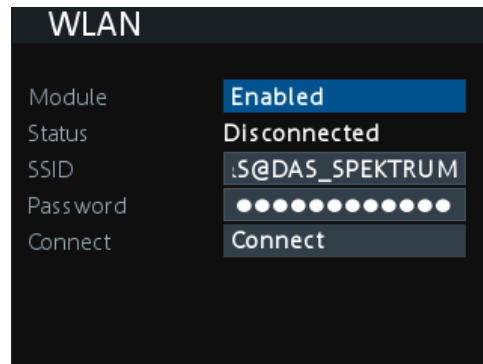

Figure 7-26: WLAN dialog

- Configure the required WLAN settings.
See details in "WLAN" on page 82.
- Select the "Connect" button.
If connection is successful, the "Status" shows "Connected". See [Figure 7-27](#).
When the connection is alive, the WLAN icon turns green on the status bar. See [Figure 5-7](#).

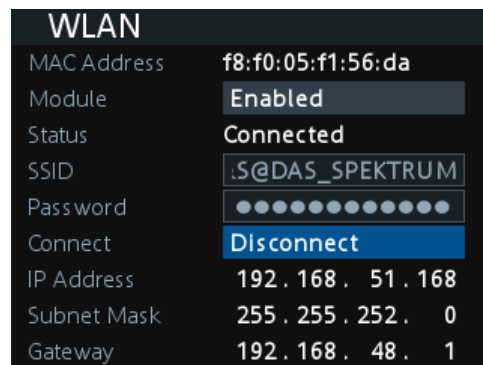

Figure 7-27: WLAN connected

- To disconnect, select "Disconnect" in the WLAN dialog.

WLAN

Settings for WLAN connection.

MAC Address ← WLAN

Displays MAC address of the R&S NGA100.

Remote command:

n.a.

Module ← WLAN

Activates/deactivates the wireless interface.

Remote command:

`SYSTEM:COMMunicate:WLAN[:STATe]` on page 108

Status ← WLAN

Displays WLAN connection status.

Remote command:

[SYSTem:COMMunicate:WLAN\[:STATe\]](#) on page 108

SSID ← WLAN

Sets SSID string of the access point if the wireless interface works as client.

SSID - Service Set Identifier, a unique ID

Remote command:

[SYSTem:COMMunicate:WLAN:SSID](#) on page 109

Password ← WLAN

Sets password of the access point if the wireless interface works as client.

Remote command:

[SYSTem:COMMunicate:WLAN:PASSword](#) on page 108

Connect ← WLAN

Connects or disconnects the connection to the wireless access point.

Remote command:

[SYSTem:COMMunicate:WLAN:CONNect](#) on page 107

[SYSTem:COMMunicate:WLAN:DISConnect](#) on page 108

IP Address ← WLAN

See "[IP Address](#)" on page 80.

Remote command:

[SYSTem:COMMunicate:WLAN:IPAddress?](#) on page 108

Subnet Mask ← WLAN

See "[Subnet Mask](#)" on page 80.

Remote command:

n.a.

Gateway ← WLAN

See "[Default Gateway](#)" on page 80.

Remote command:

n.a.

7.13.2 USB connection

**Change of USB class**

If a change in "USB Class" is detected (i.e. from "[TMC](#)" to "[VCP](#)" or vice versa), the rebooting of instrument is necessary to load the correct USB driver.

Alternatively, connect a USB cable between the [USB port](#) and PC for a USB connection. The R&S NGA100 supports "[USB TMC](#)" and "[USB VCP](#)" connection.

Access:

1. Select "USB" menu item.
The R&S NGA100 displays the "USB" dialog.

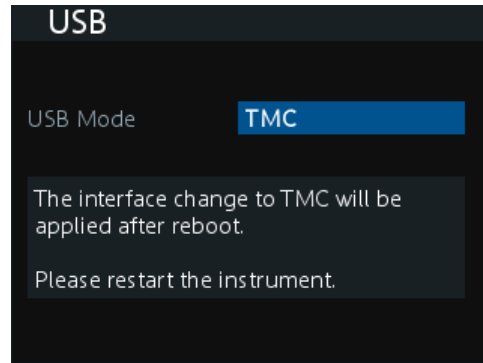

Figure 7-28: USB dialog

2. Set the desired "USB Mode".
See details in "[USB Mode](#)" on page 86.
3. Press [Enter] key to confirm the settings.
The R&S NGA100 displays message to prompt the user to restart the instrument to apply the changes.
4. Restart the R&S NGA100 to apply changes.

USB VCP



The following requirements for USB-VCP driver installation are necessary:

- A PC with operating system Windows XP, VISTA, Windows 7, Windows 8 (32Bit or 64Bit), Windows 10 or Windows 11.
- Administrator rights are necessary for the installation of the driver.

The USB virtual COM port (USB-VCP) is a software interface that allows the communication to the R&S NGA100 using any terminal program (e.g. HMEexplorer) via SCPI commands once the corresponding Windows drivers have been installed. The actual USB-VCP driver and software HMEexplorer can be downloaded for free from the product homepage (<http://www.rohde-schwarz.com/product/nga100>).

If a connection between PC and the instrument has been established and no R&S NGA100 USB-VCP driver is installed, the PC operating system displays a "Found New Hardware" wizard. In this case, the R&S NGA100 USB-VCP driver must be installed.

The HMEexplorer window application provides the R&S NGA100 a terminal function and also the option to create screenshots and editor function to create the EasyArb table.

For more information of the driver installation and HME Explorer window application, see the installation guide of the driver file and the internal HME Explorer help.

USB TMC

The USB Test & Measurement class (USB-TMC) is a protocol that allows GPIB-like communication via USB interfaces and is a separate instrument class of the USB specification. The USB-TMC protocol supports service queries, triggers, and other GPIB-specific instructions.

VISA drivers are installed and that it can be used directly in the corresponding environments. The driver is included in the NI-VISA package and can be downloaded at <http://www.ni.com/downloads/ni-drivers/>.

A major benefit of the USB TMC class is that by sampling specific registers, the controlling software can determine if commands have been terminated and if they have been processed correctly. With USB-VCP, communication with instrument requires analysis and polling mechanisms within the controlling software which may significantly strain the interface of the measurement instruments. The TMC status registers solve this problem with the USB TMC in the same manner as in the case with the GPIB interface for the hardware via the corresponding control lines.



HME Explorer

The window application supports the communication via LAN, USB VCP and WLAN only.

For more information of the VISA driver installation, see the installation guide of the VISA driver file.

Once the driver is installed, the "USB Test and Measurement Device (IVI)" is displayed in the "Device Manager" window, see [Figure 7-29](#).

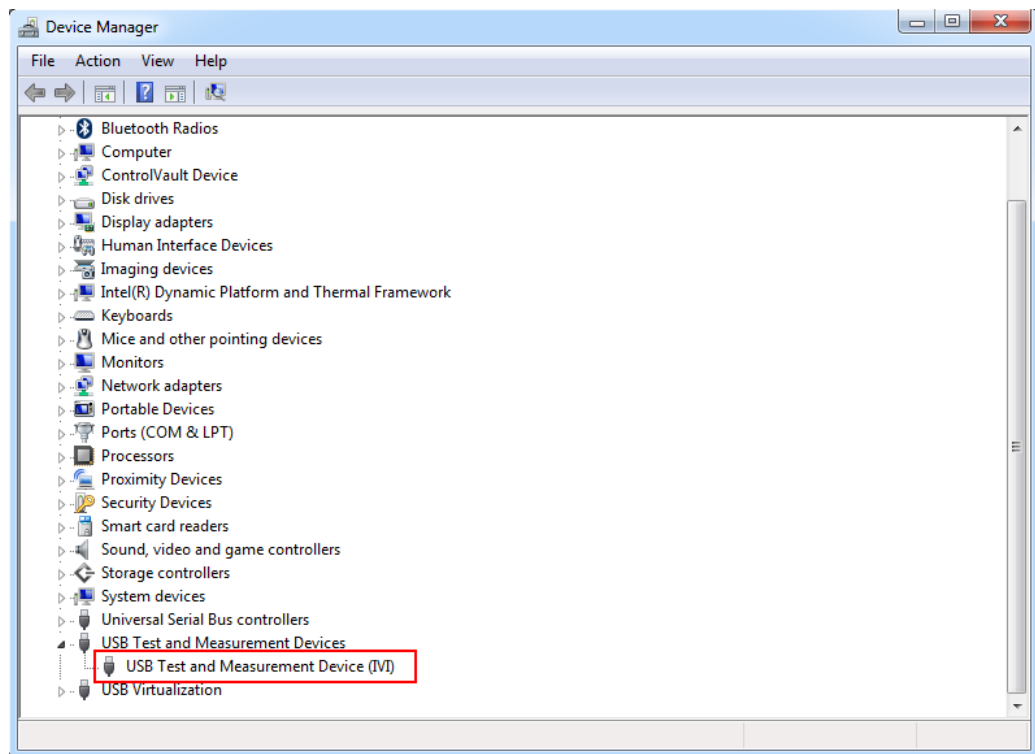

Figure 7-29: Device manager

USB Mode

Sets USB mode for USB connection.

"VCP" USB virtual COM port, see "[USB VCP](#)" on page 84.

"TMC" USB Test & Measurement class, see "[USB TMC](#)" on page 85.

Remote command:

See "[USB](#)" on page 89.

7.13.3 LXI

LAN extension for instrumentation (LXI) is a platform for measuring devices and test systems based on standard Ethernet technology. LXI is to be the LAN-based successor to GPIB and combine the advantages of Ethernet with the simple and familiar features of the GPIB. This standard provides a new standard for network configuration of front panel devices via a WEB interface. The central tool for this type of configuration is a browser.

LXI-compatible devices are divided into three classes, A, B and C, where the functionality of the classes is based on each other hierarchically:

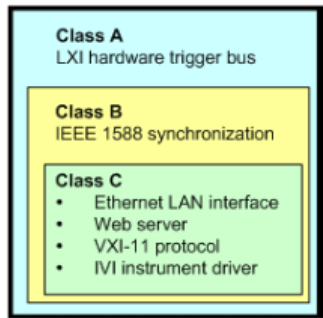

Figure 7-30: LXI classes

- Class C devices are characterized by a uniform LAN implementation including an ICMP ping responder for diagnostic purposes. Devices can be configured with a WEB browser. A LAN Configuration Initialize (LCI) mechanism resets the LAN configuration. Class C LXI devices are also intended to support automatic detection in a LAN via VXI-11 discovery protocol and programming using IVI drivers.
- Class B adds the IEEE 1588 Precision Time Protocol (PTP) and peer-to-peer communication to base class C. With IEEE 1588, all devices within a network can automatically synchronize to the most accurate available clock, and then provide time-stamps or synchronization signals for all devices with exceptional accuracy.
- Class A devices also contain the eight-channel hardware trigger bus (LVDS interface) according to the LXI standard.

Class A and B devices can send and receive software triggers through LAN messages and communicate with each other without using the controller.

The power supplies of the R&S NGA100 series meet the general requirements of the LXI Class C and correspond to the version 1.5 (LXI Core 2016). Advanced features are not supported.

A key component of an LXI certification is the IVI device driver (Interchangeable Virtual Instrument). Here IVI.NET drivers are provided, which are based on the .NET framework 4 of Microsoft. LabView and LabWindows/CVI drivers built on LabWindows/CVI 2012 are also available. The latest copy of the IVI.NET driver is available for download from the product homepage <http://www.rohde-schwarz.com/product/nga100>.

In addition to the features described above, the device provides the following LXI-related functions:

- Displays the current device settings
- Remote control of the device within the WEB-Browser

The Ethernet interface has an integrated web server, you can access the instrument with its corresponding IP address in the address line of the browser (i.e. <http://192.168.1.89>). See [Figure 7-31](#).

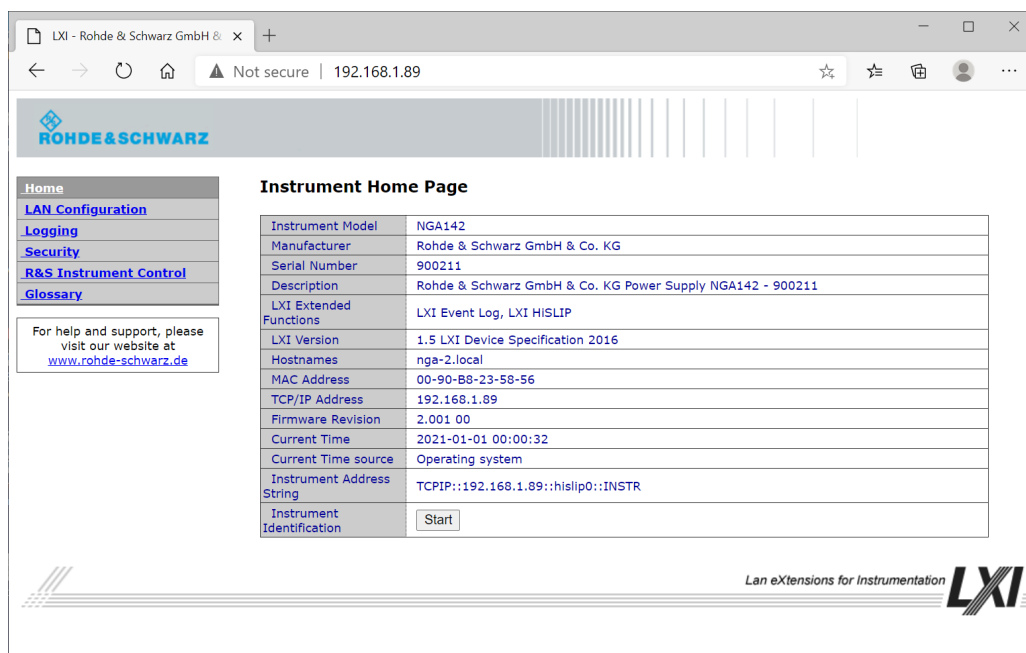

Figure 7-31: Instrument web browser view

7.13.4 SCPI

SCPI (Standard Commands for Programmable Instruments) commands - messages - are used for remote control. Commands that are not taken from the SCPI standard follow the SCPI syntax rules. The instrument supports the SCPI version 1999. The SCPI standard is based on standard IEEE 488.2 and aims at the standardization of device-specific commands, error handling and the status registers. The tutorial "Automatic Measurement Control" - A tutorial on SCPI and IEEE 488.2" from John M. Pieper (R&S order number 0002.3536.00) offers detailed information on concepts and definitions of SCPI.

The requirements that the SCPI standard places on command syntax, error handling and configuration of the status registers are explained in detail in the following sections. For more information, see [Chapter 8, "Remote control commands"](#), on page 102 and [Chapter A, "Additional basics on remote control"](#), on page 151.

7.13.5 VISA

VISA is a standardized software interface library providing input and output functions to communicate with instruments. The I/O channel (LAN or USB) is selected at initialization time by means of a channel-specific resource string. For more information about VISA, refer to its user documentation.

7.13.6 Setting up remote control connection

USB

The following shows the resource string format used when setting up a remote connection via the USB interface:

- **USB TMC**
`USB0::0x0AAD::0x0197::5601.8002<device_variant>-<device_serial_number>::INSTR` where k02 is used for NGA101 device, k03 is used for NGA141 device, k04 is used for NGA102 device, k05 is used for NGA142 device. (e.g. `USB0::0x0AAD::0x0197::5601.8002k05-900211::INSTR`)
- **USB VCP**
`ASRL<COM>::INSTR`, where "COM" refers to the COM port number shown on the controlling PC. (e.g. `ASRL15::INSTR`)

LAN/WLAN

See [Chapter 7.13.1, "Network connection"](#), on page 78 for configuring the LAN and WLAN parameters.

To set up the connection the IP address of the instrument is required. It is part of the resource string used by the program to identify and control the instrument. The resource string has the form:

```
TCPIP::< IP_address >::INST
```

Example: If the instrument has the IP address 192.1.2.3; the valid resource string is:

```
TCPIP::192.1.2.3::INST
```

High-Speed LAN Instrument Protocol (HiSLIP) is a TCP/IP-based protocol for remote instrument control of LAN-based test and measurement instruments. It was specified by the IVI Foundation and is intended to replace the older VXI-11 protocol. To start remote control session with HiSLIP, the valid resource string is:

```
TCPIP::192.1.2.3::HISLIP
```



The end character must be set to line feed (LF).

[Remote] key

Access:

1. Press [Remote] key to unlock the instrument from the remote control mode. In the remote control mode, all front panel keys on the instrument are disabled and the [Remote] key is illuminated.
2. To switch back to the local mode, press [Remote] key to release the remote control mode.

[Remote]

Toggles remote/local instrument control mode.

Remote command:

[SYSTem:LOCa1](#) on page 106

[SYSTem:RWLock](#) on page 106

[SYSTem:REMote](#) on page 106

7.14 General instrument settings

The following chapters provide the general instrument information and utilities services in R&S NGA100.

Access:

1. Press [Menu] key.
2. Select "Device" menu item to configure the required instrument settings.
3. Select "Utilities" menu item to configure the utilities services.

7.14.1 Instrument information

The "Information" dialog provides the general instrument information of R&S NGA100.

- ▶ Select "Information" menu item.
The R&S NGA100 displays the "Information" dialog. See [Figure 7-32](#).

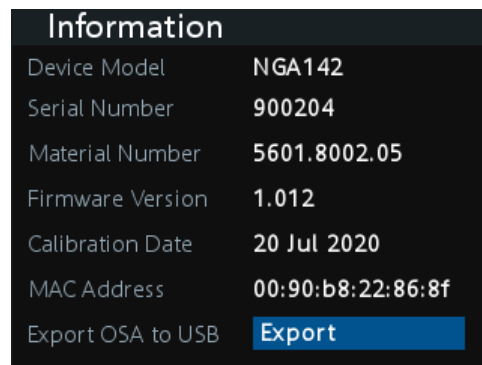

Figure 7-32: Information dialog

Information.....	91
L Device Model	91
L Serial Number	91
L Material Number	91
L Firmware Version	91

L Calibration Date.....	91
L MAC Address.....	91
L Export OSA to USB.....	91

Information

Displays instrument information.

Device Model ← Information

Model of the instrument, i.e. NGA101, NGA102, NGA141 or NGA142.

Remote command:

*IDN? on page 103

Serial Number ← Information

Unique identification number for the instrument.

Remote command:

*IDN? on page 103

Material Number ← Information

Instrument orderable part number.

Remote command:

*IDN? on page 103

Firmware Version ← Information

Software version that is installed in the instrument.

Remote command:

*IDN? on page 103

Calibration Date ← Information

The last registered date when calibration was carried out on the instrument.

Remote command:

n.a.

MAC Address ← Information

MAC address of the network interface.

Remote command:

n.a.

Export OSA to USB ← Information

The open-source acknowledgment (OSA) of the R&S NGA100 can be exported to USB stick for reference.

Remote command:

n.a.

7.14.2 General instrument settings

General instrument settings such as keypad fallback time, screen display brightness and buzzer setting are provided.

Access:

- ▶ Select "General" menu item.
The R&S NGA100 displays the "General" dialog. See [Figure 7-33](#).

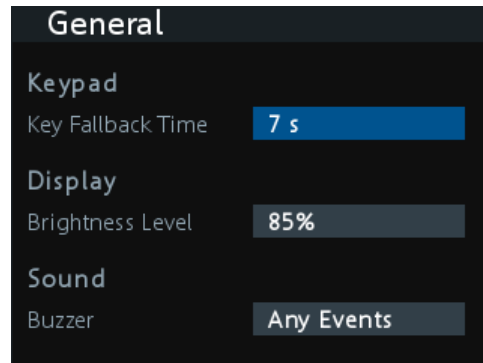

Figure 7-33: General dialog

General.....	92
L Keypad.....	92
L Display.....	92
L Sound.....	92

General

General instrument settings.

Keypad ← General

Selects the wait time before the instrument automatically leaves the editing mode. Select "Off" to disable the automatic switching back.

Remote command:

n.a.

Display ← General

Selects the specific screen intensity to control the screen brightness. Setting is applied immediately.

Remote command:

n.a.

Sound ← General

Selects the event where sound is generated.

- "Fault Events": Sounds on faulty events only
- "Any Events": Sounds on faulty events and key press events
- "Disabled": No sound is generated

Remote command:

`SYSTem:BEEPer[:IMMediate]` on page 105

7.14.3 License management

Options are enabled by entering a registered license key code.

You may choose to install from an XML file on USB or by manually entering the key code.

For unregistered license key code, see also the supplement note delivered together with the unregistered key code.

- ▶ Select "License" menu item.
The R&S NGA100 displays the "License" dialog. See [Figure 7-34](#).

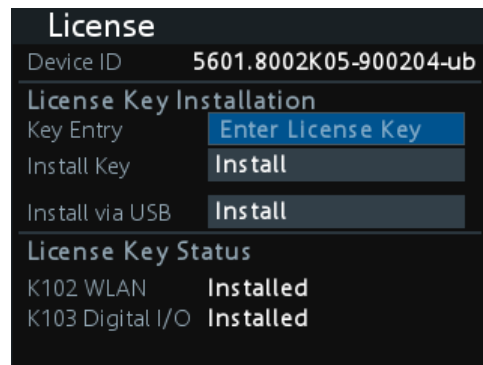

Figure 7-34: License dialog

Install via USB

To install from an XML file, proceed as follows:

1. Copy the XML file containing the registered key code into the USB flash drive.
2. Connect the USB flash drive to the USB port of the instrument.
3. Select "Install via USB" > "Install".
If the installation is successful, the option is marked as "Installed" under "Installation Status".

Install via key entry

To manually enter the key code, proceed as follows:

1. Press [Enter] key to invoke the [On-screen keyboard](#).
2. Enter the key code (30-digit number) of the option in the entry box.
3. Select "Install key" > "Install".
If the correct key code is entered, the option is marked as "Installed".

If an invalid key code is entered, an error message is displayed. Re-enter the correct key code.

License.....	94
L Device ID.....	94
L License Key Installation.....	94
L Key Entry.....	94
L Install Key.....	94
L Install via USB.....	94
L License Key Status.....	94
L <Key Option Status>.....	94

License

Installation of instrument license key and information display.

Device ID ← License

Displays of instrument device ID.

Remote command:

n.a.

License Key Installation ← License

Installation of license key settings.

Remote command:

n.a.

Key Entry ← License Key Installation ← License

Key entry for license key. See "[Install via key entry](#)" on page 93.

Remote command:

n.a.

Install Key ← License Key Installation ← License

License key installed using key entry.

Remote command:

n.a.

Install via USB ← License Key Installation ← License

License key installed using USB stick. See "[Install via USB](#)" on page 93.

Remote command:

n.a.

License Key Status ← License

Displays installed license key status.

<Key Option Status> ← License Key Status ← License

Displays of instrument key option status.

- "Installed": Instrument key option installed.
- "Not Installed": Instrument key option not installed.

Remote command:

`SYSTem:OPTion?` on page 106

`*OPT?` on page 103

7.14.4 Reset instrument

This function resets the instrument to factory default settings.

The following settings are reset to default:

- ▶ Select "Reset" menu item.
The R&S NGA100 displays the "Reset" dialog. See [Figure 7-35](#).

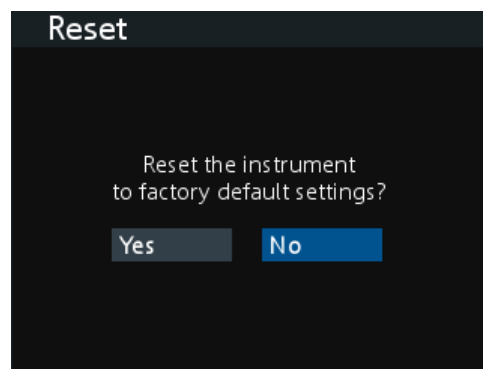

Figure 7-35: Reset dialog

The following parameters are reset to default:

Parameters	Default settings	
	R&S NGA101, R&S NGA102	R&S NGA141, R&S NGA142
Voltage, current	6.000 V, 6.050 A	20.00 V, 2.030 A
Overvoltage Protection (OVP) Status, OVP level	Measured, 36.5 V	Measured, 102.0 V
Overpower Protection (OPP) Status, OPP level	Enabled, 41.0 W	Enabled, 41.0 W
Output status	Off	
Channel history information	0	
Channel fusion "Connection Mode"	Off	
"Current Measurement Range"	High	
"Fuse Delay", "Fuse Linking"	0.00 s, Disabled	
"Remote Sense"	Disabled	
"EasyArb Mode on Ch 1"	Disabled	

Parameters	Default settings	
	R&S NGA101, R&S NGA102	R&S NGA141, R&S NGA142
EasyRamp "Output Ramping", "Ramping Time"	Disabled, 0.01 s	
Digital IO "Master Enabled" "Direction", "Channel", "Condition" "Logic", "Status"	Disabled "Trigger Out", "Ch 1", "Output On" "Active High", "Disabled"	
WLAN SSID, Password	"SSID", "....."	
General "Key Fallback Time", "Brightness Level", "Buzzer"	7 s, 85 %, Any Events	

Reset

Resets instrument to factory default settings.

Remote command:

n.a.

7.14.5 System test

This function provides a system test to check the instrument working conditions for screen color display, key backlight, beeper and cooling fan.

Access:

- ▶ Select "System Test" menu item.
The R&S NGA100 displays the "System Test" dialog. See [Figure 7-36](#).

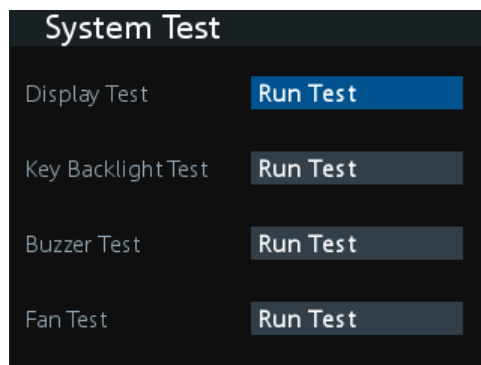

Figure 7-36: System test dialog

System Test.....97

L Display Test.....	97
L Key Backlight Test.....	97
L Buzzer Test.....	97
L Fan Test.....	97

System Test

Lists the system test for instrument.

Display Test ← System Test

System test to check if display is working. RGB and a list of supported colors should appear on the screen during the test.

Remote command:

`SYSTem:TEST:SCReen` on page 107

Key Backlight Test ← System Test

System test to check if key backlight is working.

During the test, all keys on the front panel illuminate except ([M1], [M2], [M3], [M4], [M5]) and [Store Recall].

Remote command:

`SYSTem:TEST:KEYBacklight` on page 107

Buzzer Test ← System Test

System test to check if instrument sound is working. Three beep sounds should be heard during the test.

Remote command:

`SYSTem:TEST:BEEPer` on page 106

`SYSTem:BEEPer[:IMMediate]` on page 105

Fan Test ← System Test

System test to check if cooling fan is working.

Remote command:

`SYSTem:TEST:FANCtrl` on page 107

7.14.6 Updating the firmware

The latest firmware file can be found from the product homepage <http://www.rohde-schwarz.com/product/nga100>.

For firmware update using SCPI command, see "Firmware update via SCPI command" on page 98.



Do not power off or operate the instrument during a firmware update.

Do not rename the firmware filename.

1. Download the firmware file from the product homepage.
2. Copy the firmware to the root directory of a USB flash drive.

3. Connect the USB flash drive to the USB port of the instrument and wait for ten seconds.
4. Press [Menu] key.
5. Select "Utilities" > "Update" menu item.
If firmware file is found, the R&S NGA100 displays the "Update" dialog. See [Figure 7-37](#).

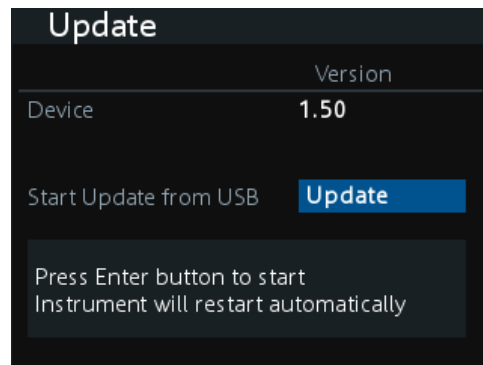

Figure 7-37: Update dialog

6. Press [Enter] key to start firmware update process.
The R&S NGA100 reboots automatically as part of the update process.
7. Alternatively, you can press [Back] key to cancel the firmware update process.
8. Wait for the completion of the update process.
It takes a few minutes to complete the firmware update process.

Firmware update via SCPI command

1. Download the firmware file from the product homepage.
2. Copy the firmware to the root directory of a USB flash drive.
3. Connect the USB flash drive to the USB port of the instrument and wait for ten seconds.
4. Connect to the instrument via [USB](#), [LAN](#) or [WLAN](#).
5. Send `DIAGnostic:SERvice:FWUP "/FRONT_USB/NGA1xx"` to start firmware update remotely.
The R&S NGA100 reboots automatically as part of the update process.
6. Wait for the completion of the update process.
It takes a few minutes to complete the firmware update process.

Update

Displays instrument firmware update information.

Device ← Update

Displays the instrument firmware version to be updated.

Remote command:
n.a.

Start Update from USB ← Device ← Update

Displays the firmware update status from USB.

Remote command:

[DIAGnostic:SERVice:FWUP](#) on page 141

7.14.7 Help

The "Help" dialog provides the internet link and QR code for the latest R&S NGA100 information.

1. Select "Help" menu item.

The R&S NGA100 displays the "Help" dialog. See [Figure 7-38](#).



Figure 7-38: Help dialog

2. Use a QR code reader to scan the QR code to link to the online product home page.
Alternatively, you could enter the address: <http://www.rohde-schwarz.com/product/nga100> into a browser to access the latest help information.

7.14.8 Date time

The "Date Time" dialog provides the configuration to set system date and time.

1. Select "Date Time" menu item.
The R&S NGA100 displays the "Date Time" dialog.

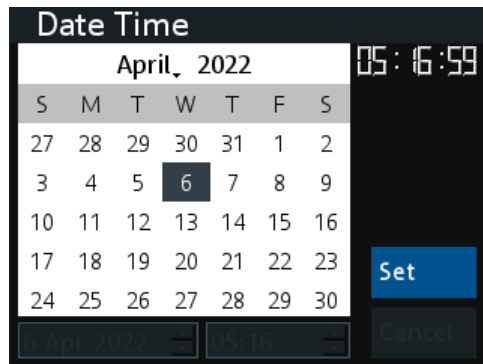

Figure 7-39: Date time dialog

2. Select "Set" to change the system date and time.
The R&S NGA100 displays a dialog to set date and time in "dd mm yyyy" and "hh mm" format respectively.

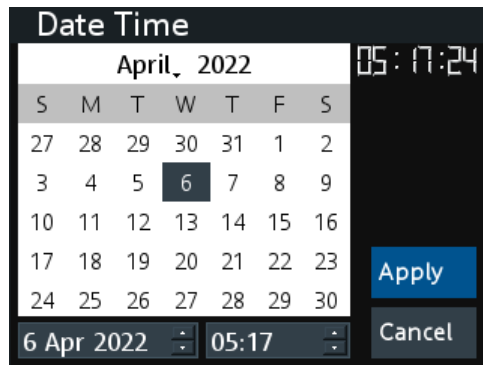

Figure 7-40: Setting of date and time

3. Select "Apply" to confirm the changes.
The R&S NGA100 sets the required date and time accordingly.

Date Time.....	100
L <Calendar>.....	100
L Current Time.....	101
L Date.....	101
L Time.....	101
L Apply.....	101
L Cancel.....	101

Date Time

Sets system date and time for the instrument.

<Calendar> ← Date Time

Displays instrument calendar for setting.

Remote command:

n.a.

Current Time ← Date Time

Displays instrument current system time.

Remote command:

n.a.

Date ← Date Time

Sets instrument system date.

Remote command:

n.a.

Time ← Date Time

Sets instrument system time.

Remote command:

n.a.

Apply ← Date Time

Confirms date and time settings for instrument.

Remote command:

n.a.

Cancel ← Date Time

Cancels date and time settings for instrument.

Remote command:

n.a.

8 Remote control commands

This chapter provides the description of all remote commands available for the R&S NGA100 series. The commands are sorted according to the menu structure of the instrument. A list of commands in alphabetical order is given in the "List of commands" at the end of this documentation.

For more information on [Messages and SCPI command structure](#), see the "Annex" at the end of this documentation.

8.1 Common setting commands

Common commands are described in the IEEE 488.2 (IEC 625-2) standard. These commands have the same effect and are employed in the same way on different devices. The headers of these commands consist of "*" followed by three letters.

Many common commands are related to the Status Reporting System.

*CLS.....	102
*ESE.....	102
*ESR?.....	103
*IDN?.....	103
*OPC.....	103
*OPT?.....	103
*RST.....	104
*SRE.....	104
*STB?.....	104
*TST?.....	104
*WAI.....	105
*SAV.....	105
*RCL.....	105

*CLS

Clear status

Sets the status byte (STB), the standard event register (ESR) and the `EVENT` part of the `QUESTIONABLE` and the `OPERATION` registers to zero. The command does not alter the mask and transition parts of the registers. It clears the output buffer.

Usage: Setting only

*ESE <Value>

Event status enable

Sets the event status enable register to the specified value. The query returns the contents of the event status enable register in decimal form.

Parameters:

<Value> Range: 0 to 255

***ESR?**

Event status read

Returns the contents of the event status register in decimal form and then sets the register to zero.

Return values:

<Contents> Range: 0 to 255

Usage: Query only

***IDN?**

Identification

Returns the instrument identification.

Return values:

<ID> "Rohde&Schwarz,<device type>,<part number>,<serial number>,<firmware version>"

Example: Rohde&Schwarz, NGA100, 5601.8002k05/900221, 4.0020026AE592

Manual operation: See "[Device Model](#)" on page 91
 See "[Serial Number](#)" on page 91
 See "[Material Number](#)" on page 91
 See "[Firmware Version](#)" on page 91

***OPC**

Operation complete

Sets bit 0 in the event status register when all preceding commands have been executed. This bit can be used to initiate a service request. The query writes a "1" into the output buffer when all preceding commands have been executed, which is useful for command synchronization.

The R&S NGA100 does not support parallel processing of remote commands. If the query *OPC? returns a „1“, the device is able to process new commands.

***OPT?**

Option identification query

Queries the options included in the instrument. For a list of all available options and their description, refer to the data sheet.

Usage: Query only

Manual operation: See "<Key Option Status>" on page 94

*RST

Reset

Sets the instrument to a defined default status. The default settings are indicated in the description of commands.

We recommend to start a program by *RST in order to set the instrument to a defined status prior to starting a program.

Usage: Setting only

*SRE <Contents>

Service request enable

Sets the service request enable register to the indicated value. This command determines the conditions under which a service request is triggered.

The SRE is an enable register. Consequently, there are no denotations about the bits. This register conduces for the "OR" combination of the bits in the status byte.

Parameters:

<Contents> Contents of the service request enable register in decimal form.
 Bit 6 (MSS mask bit) is always 0.
 Range: 0 to 255

*STB?

Status byte query

Reads the contents of the status byte in decimal form.

Usage: Query only

*TST?

Self-test query

Initiates self-tests of the instrument and returns an error code.

Return values:

<ErrorCode> **integer > 0 (in decimal format)**
 An error occurred.
 0
 No errors occurred.

Usage: Query only

***WAI**

Wait to continue

Prevents servicing of the subsequent commands until all preceding commands have been executed and all signals have settled (see also command synchronization and [*OPC](#)).

Usage: Event

***SAV <Number>**

Save

Stores the current instrument settings under the specified number in an internal memory. The settings can be recalled using the command [*RCL](#) with the associated number.

Parameters:

<Number> Range: 0..4

Manual operation: See "[M1] / [M2] / [M3] / [M4] / [M5]" on page 46
See "[Store Recall]" on page 46
See "[Store Recall]" on page 78

See also "[Store instrument settings](#)" on page 77.

***RCL <Number>**

Recall

Loads the instrument settings from an internal memory identified by the specified number. The instrument settings can be stored to this memory using the command [*SAV](#) with the associated number.

Parameters:

<Number> Range: 0..4

Manual operation: See "[M1] / [M2] / [M3] / [M4] / [M5]" on page 46
See "[Store Recall]" on page 46
See "[Store Recall]" on page 78

See also "[Recall instrument settings](#)" on page 77.

8.2 System commands

The `SYSTEM` commands perform the various system functions and configure the communication interface (LAN, WLAN) for the instrument.

SYSTEM:BEEP[:IMMEDIATE]

Returns a single beep immediately.

Usage: Event
Manual operation: See "[Sound](#)" on page 92
See "[Buzzer Test](#)" on page 97

SYSTem:LOCa1

Sets the system to front panel control. The front panel control is unlocked.

Usage: Event
Manual operation: See "[\[Remote\]](#)" on page 45
See "[\[Remote\]](#)" on page 90

SYSTem:REMOte

Sets the system to remote state. The front panel control is locked. By pressing **Remote**, the front panel control will be activated.

Usage: Event
Manual operation: See "[\[Remote\]](#)" on page 45
See "[\[Remote\]](#)" on page 90

SYSTem:RWLOCK

Sets the system to remote state. The front panel control is locked. You are only able to unlock the front panel control via SCPI command [SYSTem:LOCa1](#) on page 106.

Usage: Event
Manual operation: See "[\[Remote\]](#)" on page 45
See "[\[Remote\]](#)" on page 90

SYSTem:OPTion?

Returns the list of options installed on the instrument.

Return values:
<arg0>

Usage: Query only
Manual operation: See "[<Key Option Status>](#)" on page 94

SYSTem:TEST:BEEPer

Runs the system test: Beeper Test.

Usage: Event
Manual operation: See "[Buzzer Test](#)" on page 97

SYSTem:TEST:FANCtrl

Runs the system test: Fan Control Test.

Usage: Event

Manual operation: See "[Fan Test](#)" on page 97

SYSTem:TEST:KEYBacklight

Runs the system test: Keypad Backlight Test.

Usage: Event

Manual operation: See "[Key Backlight Test](#)" on page 97

SYSTem:TEST:SCREen

Runs the system test: Screen Color Test.

Usage: Event

Manual operation: See "[Display Test](#)" on page 97

SYSTem:COMMunicate:SOCKet:DHCP[:STATe] <arg0>
SYSTem:COMMunicate:SOCKet:DHCP[:STATe]?

Sets or queries LAN interface mode. ON: automatic IP address from DHCP server; OFF: manually set IP address.

Parameters:

<arg0>

Manual operation: See "[Status](#)" on page 80
See "[IP Mode](#)" on page 80

SYSTem:COMMunicate:SOCKet:IPADdress?

Queries IP address of the LAN interface.

Return values:

<arg0>

Usage: Query only

Manual operation: See "[IP Address](#)" on page 80

SYSTem:COMMunicate:WLAN:CONNect

Connects to the predefined wireless access point.

Usage: Event

Options: R&S NGA-K102

Instrument with serial number below 110000

Manual operation: See "[Connect](#)" on page 83

SYSTem:COMMunicate:WLAN:DISConnect

Stops the connection to the predefined wireless access point.

Usage: Event

Options: R&S NGA-K102
Instrument with serial number below 110000

Manual operation: See "[Connect](#)" on page 83

SYSTem:COMMunicate:WLAN:IPADdress?

Queries the IP address of the device when the wireless interface works as a client.

Return values:

<arg0>

Usage: Query only

Options: R&S NGA-K102
Instrument with serial number below 110000

Manual operation: See "[IP Address](#)" on page 83

SYSTem:COMMunicate:WLAN[:STATe] <arg0>

Activates/deactivates or queries the enable state of the wireless interface.

Parameters:

<arg0>

Options: R&S NGA-K102
Instrument with serial number below 110000

Manual operation: See "[Module](#)" on page 82
See "[Status](#)" on page 83

SYSTem:COMMunicate:WLAN:PASSword <arg0>

Defines the password string of the Access Point when the wireless interface works as a client.

Parameters:

<arg0>

Usage: Setting only

Options: R&S NGA-K102
Instrument with serial number below 110000

Manual operation: See "Password" on page 83

SYSTem:COMMunicate:WLAN:SSID <arg0>

SYSTem:COMMunicate:WLAN:SSID?

Defines or queries the SSID string of the access point when the wireless interface works as a client.

Parameters:

<arg0>

Options:

R&S NGA-K102

Instrument with serial number below 110000

Manual operation: See "SSID" on page 83

8.3 Configuration commands

The following subsystems contain the commands for channel selection, voltage and current settings for the instrument.

8.3.1 Channel selecting

The `INSTRument:Select` subsystem contains the commands for selecting the output channels.

Each channel of the power supply is considered as separate "instrument", which is required by the SCPI standard. Therefore, the SCPI commands use the `INSTRument` node to select a channel.



You can only address the number of channels a device is equipped with, e.g. a maximum of two channels for the NGA102 and NGA142.

Example: Selecting a channel

You can select a channel either with an `OUTput` parameter, or just by the channel number. This example lists all ways how you can select and query a selected channel.

```
// *****
// Select a channel
// *****
// selects channel 1
INST OUT1
// queries the channel selection
INST?
// response: "OUTPut1"
// *****
// Select a channel by its number
// *****
// selects channel number 1
INST:NSEL 1
// queries number of the channel selection
INST:NSEL?
// response: 1
```

INSTRument:NSElect <arg0>**INSTRument:NSElect?**

Defines or queries the numeric selection of a channel. Each channel of the power supply is considered as separate "instrument", which is required by the SCPI standard.

Parameters:

<arg0> {1 | 2}

Example:

```
INSTRument:NSElect 1
Selects the output channel as Ch 1.
INSTRument:NSElect? -> 1
Return the numeric channel selection.
```

Manual operation: See "[Ch 1] / [Ch 2]" on page 44

INSTRument[:SElect] <arg0>**INSTRument[:SElect]?**

Defines or queries the channel selection. Each channel of the power supply is considered as separate "instrument", which is required by the SCPI standard.

Parameters:

<arg0> OUTPut1 | OUTPut2 | OUTP1 | OUTP2 | OUT1 | OUT2
OUTPut1 | OUTP1 | OUT1
 Ch 1
OUTPut2 | OUTP2 | OUT2
 Ch 2

Example: INSTRument OUTPut1
 INSTRument OUTP1
 Selects the output channel as Ch 1.
 INST? -> 2
 Return the output channel as Ch 2.

Manual operation: See "[Ch 1] / [Ch 2]" on page 44

8.3.2 Remote sense setting

The VOLTage:SENSe subsystem contains the command for setting the remote sense for the instrument.

[SOURce:]VOLTage:SENSe <arg0>
[SOURce:]VOLTage:SENSe?

Sets or queries the remote sense state of the previous selected channel.

Parameters:

<arg0> EXTernal | DISable

EXTernal | EXT

The internal voltage sense relay in the instrument is switched on and the connection of remote sense wires (S+, S-) to the input of the load become necessary.

Failure to connect remote sense can cause over voltage or unregulated voltage output from the R&S NGA100. The voltage sense relay remains switched on even when output is turned off.

DISable | DIS

Remote sense is disabled.

Example: VOLT:SENS EXT
 VOLT:SENS? -> EXTernal
 Remote sense state is EXT.

Manual operation: See "[Remote Sense](#)" on page 57

8.3.3 Voltage setting

The SOURce:VOLTage subsystem contains the commands for setting the voltage of the output channel. The default unit is V.

Example: Configuring the output voltage

This example contains all commands to configure and query the output voltage.

```
// *****
// Select the channel
// *****
INST OUT1
// *****
// Set the voltage value
// *****
// selects a channel and sets the voltage
VOLT 10
// queries the output voltage of a channel
VOLT?
// response: 10.000
// sets the voltage to maximum or minimum respectively
VOLT MAX
VOLT MIN
// *****
// Query the range of the voltage values
// *****
// queries the upper and lower limit of the output voltage
VOLT? MIN
// response: 0.000
VOLT? MAX
// response: 35.05 for NGA101, NGA102 and 100.05 for NGA141, NGA142
```

**[SOURce:]VOLTage[:LEVel][:IMMediate][:AMPLitude] <Voltage>
[SOURce:]VOLTage[:LEVel][:IMMediate][:AMPLitude]?**

Defines or queries the voltage value of the selected channel.

Parameters:

<Voltage> {<Voltage> | MINimum | MAXimum | DEFault}

<Voltage>
0.0 V to 35.05 V for R&S NGA101 and R&S NGA102 models
(adjustable in 1 mV steps).
0.0 V to 100.05 V for R&S NGA141 and R&S NGA142 models
(adjustable in 10 mV steps).

MINimum
0.000E+00

MAXimum
35.05 V for R&S NGA101 and R&S NGA102 models.
100.05 V for R&S NGA141 and R&S NGA142 models.

Default unit: V

Example:

```
VOLT 10
Set the voltage value to 10 V.
VOLT? -> 10
Return the voltage value of the selected channel.
```

Manual operation: See "[Voltage]" on page 45
See "Set output voltage and current" on page 53

8.3.4 Current setting

The `SOURce:CURRent` subsystem contains the commands for setting the current limit of the output channel. The default unit is A.

Example: Configuring the current output

```
// *****
// Select the channel
// *****
INST OUT1
// *****
// Set the current value
// *****
// selects a channel and sets the current
CURR 2
// queries the current of the selected channel
CURR?
// response: 2.000
// *****
// Query the range of the current values
// *****
// queries the upper and lower limit of the current
CURR? MIN
// response: 0.001
CURR? MAX
// response: 6.05 for NGA101 and NGA102 and 2.03 for NGA141 and NGA142
```

[SOURce:]CURRent[:LEVel][:IMMediate][:AMPLitude] <Current>
[SOURce:]CURRent[:LEVel][:IMMediate][:AMPLitude]?

Defines or queries the current value of the selected channel.

Parameters:

<Current>

<Current>

Set current in the range of 1 mA to 6.05 A for R&S NGA101 and R&S NGA102 models or 1 mA to 2.03 A for R&S NGA141 and R&S NGA142 models.

Default unit: A

Example:

`CURR 2`

Set the selected channel current to 2 A.

`CURR? -> 2`

Return current value of the selected channel.

Manual operation: See "[Current]" on page 45
See "Set output voltage and current" on page 53

[SOURce:]CURRent:RANGe <arg0>
[SOURce:]CURRent:RANGe?

Sets or queries the current range of the selected channel.

Parameters:

<arg0> AUTO | HIGH | LOW

AUTO

The measured output current is displayed in the following:

- "A" with 10 μ A resolution for current above 200 mA.
- "mA" with 1 μ A resolution for current below 200 mA.

HIGH

The measured output current is displayed in "A" with 10 μ A resolution.

LOW

The measured output current is displayed in "mA" with 1 μ A resolution.

Manual operation: See "[Current Measurement Range](#)" on page 55

8.3.5 Combined voltage and current settings

The `APPLY` subsystem provides a command that enables you to set the current and voltage of a channel in one step.

APPLY <arg0>
APPLY?

Defines or queries the voltage and current value of the selected channel.

Parameters:

<arg0> {<Voltage> | DEF | MIN | MAX} [, {<Current> | DEF | MIN | MAX}]

<Voltage>

Set voltage in the range of 0 V to 35.05 V for R&S NGA101 and R&S NGA102 models or 100.05 V for R&S NGA141 and R&S NGA142 models.

DEF

Set voltage to default.

MIN

Set voltage to minimum.

MAX

Set voltage to maximum.

<Current>

Set current in the range of 1 mA to 6.05 A for R&S NGA101 and R&S NGA102 models or 1 mA to 2.03 A for R&S NGA141 and R&S NGA142 models.

DEF

Set current to default.

MIN

Set current to minimum.

MAX

Set current to maximum.

Example:

```
INST OUT1
```

```
APPLY "6,2"
```

Set channel 1 to output 6 V and 2 A.

```
APPLY? -> 6, 2
```

Return voltage and current value of the selected channel.

Manual operation:

See "[Voltage]" on page 45

See "[Current]" on page 45

See "Set output voltage and current" on page 53

8.3.6 Output setting

The `OUTPut` subsystem contains the commands for activating the output channels.

Example: Activating the channels

You can activate a selected channel and turn on or off the outputs either individually or all outputs simultaneously. This example lists all ways how you can activate and query the outputs.

```
// *****
// Activate a channel
// *****
INST OUT1
// activates the selected channel
OUTP:SEL 1
// activates channel 1 and its output
OUTP 1
// queries the output state
OUTP?
// response: 1
// *****
// Turn on all selected channels simultaneously
// *****
// selects channels 1 and 2
// sets the voltage and current values for both channels
// activates both channels
INST:OUT1
VOLT 6
CURR 0.1
OUTP:SEL 1
INST:OUT2
VOLT 12
CURR 0.2
OUTP:SEL 1
// turns on the output of both channels
OUTP:GEN 1
```

OUTPut[::STATe] <arg0>

OUTPut[::STATe]?

Defines or queries for output state for the previous selected channel.

Parameters:

<arg0> {OFF | ON | 0 | 1}

ON | 1
Output state will be turned on.

OFF | 0
Output state will be turned off.

*RST: OFF | 0

- Example:** INST OUT1
 OUTP ON
 Ch 1 and output state will be activated; i.e. **Ch 1** and **Output** key on the front panel will be illuminated.
 OUTP? -> 1
 Return the output state.
- Manual operation:** See "[Output]" on page 44
 See "[Activating the channel output](#)" on page 54

OUTPut:FUSion <arg0>
OUTPut:FUSion?

Sets or queries the output fusion state for 2-channel model.

Parameters:

- <arg0> OFF | SERies | PARallel
- OFF**
 Output fusion state is off.
- SERies**
 Output fusion state is set to series.
- PARallel**
 Output fusion state is set to parallel.

- Example:** OUTP:FUS SER
 OUTP:FUS? -> SER
 Output fusion state is set to series.

- Manual operation:** See "[Connection Mode](#)" on page 59

OUTPut:GENeral <arg0>
OUTPut:GENeral?

Sets or queries the instrument master output state.

If the master output state is activated, the [Output] key on the front panel will be illuminated.

Parameters:

- <arg0> {OFF | ON | 0 | 1}
- ON | 1**
 Output state will be activated.
- OFF | 0**
 Output state will be deactivated.

Example:

```

INST OUT1
OUTP:SEL ON
VOLT 12
CURR 0.1
Ch 1 is activated.

INST OUT2
OUTP:SEL ON
VOLT 12
CURR 0.2
Ch 2 is activated.
OUTP:GEN ON
Ch 1 and Ch 2 and output state are activated.
OUTP:GEN? -> 1
Return output state of the channel.

```

Manual operation: See "[Output]" on page 44
 See "Activating the channel output" on page 54

OUTPut:MODE?

Queries the output operating mode of the specified channel

Return values:

<arg0> {OFF | CV | CC}

OFF
Output is turned off.

CV
Output mode changed to constant voltage mode.

CC
Output mode changed to constant current mode.

Example:

```

OUTP:MODE? -> CV
Return output mode as constant voltage mode.

```

Usage: Query only

OUTPut:SElect <arg0>

OUTPut:SElect?

Sets or queries the instrument channel state of the previous selected channel.

If the selected channel is activated, the respective channel key (i.e. Ch 1, Ch 2) on the front panel will be illuminated.

Parameters:

<arg0> {OFF | ON | 0 | 1}

ON | 1
Selected channel is activated.

OFF | 0
Selected channel is deactivated.

*RST: OFF | 0

Example: INST OUT1
 OUTP:SEL ON
 Ch 1 is activated.

Manual operation: See "[Output]" on page 44
 See "Activating the channel output" on page 54

OUTP:SEL? -> 1

Return the state of the selected channel.

OTP:TRIPped?

Queries the overtemperature protection (OTP) tripped state of the previous selected channel.

It is tripped if an OTP event occurs.

Return values:

<arg0> {OFF | ON | 0 | 1}
ON | 1
 OTP event occurs.
OFF | 0
 OTP event not occurs.
 *RST: OFF | 0

Example: OUTP:TRIP? -> 1
 OTP event occurs.

Usage: Query only

8.3.7 Fuse setting

The FUSE subsystem contains the commands for overcurrent protection parameters such as activating fuses and setting fuse parameters of the output channels. The default unit is A.

Example: Configuring fuses

This example contains all commands to configure and query the fuse states and settings.

```
// *****
// Activate a fuse
// *****
INST OUT1
// selects a channel and activates the overcurrent protection
FUSE 1
// queries the state of the overcurrent protection in the selected channel
FUSE?
// response: 1
// *****
// Set a delay time for the overcurrent protection. The delay time
// takes effect when the channel output is turned on.
// *****
// sets 0.05 s delay for the overcurrent protection
FUSE:DEL 0.05
// queries the currently set delay time of the overcurrent protection
// in the selected channel
FUSE:DEL?
// response: 0.05
// sets the delay time to maximum, minimum respectively
FUSE:DEL MAX
FUSE:DEL MIN
// *****
// Query the range of the overcurrent protection delay time
// *****
// queries the upper and lower limit of the
// overcurrent protection delay time in s
FUSE:DEL? MIN
// response: 0
FUSE:DEL? MAX
// response: 10
// *****
// Query a tripped overcurrent protection
// *****
INST OUT1
//queries whether the OCP in channel 1 has tripped
FUSE:TRIP?
//response: 1 OCP is tripped
//response: 0 OCP is not tripped
//resets a tripped OCP in the selected channel
FUSE:TRIP:CLEAr
// *****
// Link the electronic overcurrent protection of the channels logically
// *****
INST OUT1
// links the overcurrent protection of channel 1 with channel 2
```

```

FUSE:LINK 2
// queries the combined overcurrent protection of the selected channel
FUSE:LINK? 2
// response 1
// *****
// Unlink linked overcurrent protection
// *****
FUSE:UNLink 2
// queries the combined overcurrent protection of the selected channel
FUSE:LINK? 2
// response 0

```

FUSE:DElAy <Delay>**FUSE:DElAy?**

Defines and queries the fuse delay for the previous selected channel.

Parameters:

<Delay> {<Delay> | MIN | MAX}

<delay>
0 s to 10 s (adjustable in 0.01 s steps e.g. FUSE:DEL 0.01 = 0.01 s).

MIN
Set fuse delay to minimum.

MAX
Set fuse delay to maximum.

Default unit: s

Example:

```

INST OUT1
FUSE:DEL 0.05
Set fuse delay of channel 1 to 50 ms.
FUSE:DEL? -> 0.05
Return the fuse delay time of the selected channel.

```

Manual operation: See "[Fuse Delay](#)" on page 62

FUSE:LINK <arg0>**FUSE:LINK?**

Defines or queries the channel fuses (fuse linking) for the previous selected channel.

Parameters:

<arg0> **1**
Sets fuse linking with Ch 1.

2
Sets fuse linking with Ch 2.

Example:

```
INST OUT1
FUSE:LINK 2
Fuse Ch 1 is linked with Ch 2.
FUSE:LINK? 2 -> 1
If the fuse of Ch 1 is linked with Ch 2, a "1" is returned.
```

Manual operation: See "[Fuse Linking](#)" on page 62

FUSE:TRIPped?

Queries the fuse tripped of the previous selected channel.

Return values:

<arg0>

ON
Fuse is tripped.

OFF
Fuse is not tripped.

Example:

```
INST OUT1
FUSE:TRIP? -> 0
Fuse of Ch 1 has not tripped.
```

Usage: Query only

Manual operation: See "[\[Fuse\]](#)" on page 60

FUSE:UNLink <arg0>

Unlinks the channel fuses (fuse linking) for the previous selected channel.

Parameters:

<arg0>

1
Unlink fuse linking with Ch 1.

2
Unlink fuse linking with Ch 2.

Example:

```
INST OUT1
FUSE:LINK 2
FUSE:UNL 2
Fuse Ch 1 is unlinked with Ch 2.
```

Usage: Setting only

Manual operation: See "[Fuse Linking](#)" on page 62

FUSE[:STATe] <arg0>

FUSE[:STATe]?

Defines or queries the fuse for the previous selected channel.

Parameters:

<arg0> {0 | 1}

1
Fuse is activated.

0
Fuse is deactivated.

*RST: OFF | 0

Example:

```
INST OUT1
FUSE ON
Fuse of Ch 1 is activated.
FUSE? -> 1
Return fuse state of the selected channel.
```

Manual operation: See "[Fuse]" on page 45
See "[Fuse]" on page 60

8.3.8 OVP setting

The `VOLTage:PROTection` subsystem contains the commands for setting the over-voltage protection parameters for the output channels. The default unit is V.

Example: Configuring the overvoltage protection

```

// *****
// Set the overvoltage protection value
// *****
INST OUT1
//activates the OVP of the previous selected channel
VOLT:PROT 1
// selects a channel and sets the OVP
VOLT:PROT:LEV 5
// queries the output overvoltage value of a channel
VOLT:PROT:LEV?
// response: 5
// queries the OVP state of the previous selected channel
VOLT:PROT?
// response: 1
// sets the overvoltage protection to maximum,
// or minimum respectively
VOLT:PROT:LEV MAX
VOLT:PROT:LEV MIN
// *****
// Query the range of the overvoltage protection values
// *****
// queries the upper and lower limit
VOLT:PROT:LEV? MIN
// response: 0.100
VOLT:PROT:LEV? MAX
// response: 36.5 for R&S NGA101, R&S NGA102 and 102 for R&S NGA141, R&S NGA142
// *****
// Query a tripped overvoltage protection
// *****
INST OUT1
// queries whether the OVP in channel 1 has tripped
VOLT:PROT:TRIP?
// response: 1 OVP is tripped
// response: 0 OVP is not tripped
// resets a tripped OVP in the selected channel
VOLT:PROT:CLEAr
// *****
// Set the overvoltage protection mode
// *****
INST OUT1
// sets OVP protected mode for channel1
VOLT:PROT:MODE PROT
// queries the OVP mode
VOLT:PROT:MODE?
// response: "PROTEcted"

```

[SOURce:]VOLTage:PROTection:MODE <arg0>
[SOURce:]VOLTage:PROTection:MODE?

Defines or queries the OVP mode for the previous selected channel.

Parameters:

<arg0> MEASured | PROTeCted

MEASured

The OVP switches off if the measured value exceeds the threshold.

PROTeCted

If the adjusted threshold is exceeded the output of the instrument will be not switched on; additionally the measured value is monitored (please also refer to function MEASured).

Example:

```
INST OUT1
VOLT:PROT:MODE PROT
Sets OVP protected mode for Ch 1.
VOLT:PROT:MODE? -> PROTeCted
Return the selected channel OVP mode.
```

Manual operation: See "[Mode](#)" on page 64

[SOURce:]VOLTage:PROTection:TRIPped?

Queries the OVP tripped status of the previous selected channel.

Return values:

<arg0> ON | OFF
ON
 OVP is tripped
OFF
 OVP is not tripped

Example:

```
INST OUT1
VOLT:PROT:TRIP? -> OFF
OVP of Ch 1 has not tripped.
```

Usage: Query only

Manual operation: See "[Overvoltage Protection \(OVP\)](#)" on page 64

[SOURce:]VOLTage:PROTection[:STATe] <arg0>
[SOURce:]VOLTage:PROTection[:STATe]?

Defines or queries the OVP state for the previous selected channel.

Parameters:

<arg0> 1 | 0
1
 OVP is activated.

0

OVP is deactivated.

Example:

INST OUT1

VOLT:PROT ON

OVP of Ch 1 is activated.

VOLT:PROT? -> 1

Return the OVP state of the selected channel.

Manual operation: See "[Overvoltage Protection \(OVP\)](#)" on page 64**[SOURce:]VOLTage:PROTection:LEVel <Voltage>****[SOURce:]VOLTage:PROTection:LEVel?**

Defines or queries the OVP value of the previous selected channel.

Parameters:

<Voltage> {<Voltage> | MIN | MAX}

<Voltage>

Set the OVP value in the range of 0 mV up to 36.5 V for R&S NGA101 and R&S NGA102 models or 0 mV up to 102 V for R&S NGA141 and R&S NGA142 models (adjustable in 100 mV steps):

MIN

Set the OVP value to minimum.

MAX

Set the OVP value to maximum.

Default unit: V

Example:

INST OUT1

VOLT:PROT:LEV 5

Set the OVP value of Ch 1 to 5 V.

VOLT:PROT:LEV?

Return the selected channel OVP value.

Manual operation: See "[Level](#)" on page 65**[SOURce:]VOLTage:PROTection:CLEar**

Resets the OVP state of the selected channel. If the OVP has tripped, the OVP message on the display will be cleared for the selected channel.

Usage: Event**Manual operation:** See "[Overvoltage Protection \(OVP\)](#)" on page 64

8.3.9 OPP setting

The `POWer:PROTection` subsystem contains the commands for setting the over-power protection parameters for the output channels. The default unit is W.

Example: Configuring the overpower protection

```
// *****
// Set the overpower protection value
// *****
INST OUT1
//activates the OPP of the previous selected channel
POW:PROT 1
// selects a channel and sets the OPP
POW:PROT:LEV 5
// queries the output overvoltage value of a channel
POW:PROT:LEV?
// response: 5
// queries the OPP state of the previous selected channel
POW:PROT?
// response: 1
// sets the overvoltage protection to maximum,
// or minimum respectively
POW:PROT:LEV MAX
POW:PROT:LEV MIN
// *****
// Query the range of the overpower protection values
// *****
// queries the upper and lower limit
POW:PROT:LEV? MIN
// response: 0.0
POW:PROT:LEV? MAX
// response: 41.0
// *****
// Query a tripped overpower protection
// *****
INST OUT1
// queries whether the OPP in channel 1 has tripped
POW:PROT:TRIP?
// response: 1 OPP is tripped
// response: 0 OPP is not tripped
// resets a tripped OPP in the selected channel
POW:PROT:CLEAr
```

[SOURCE:]POWER:PROTECTION:LEVEL <Power>
[SOURCE:]POWER:PROTECTION:LEVEL?

Defines or queries the OPP value of the previous selected channel.

Parameters:

<Power> {<Voltage> | MIN | MAX}

<Voltage>

Set the OPP value in the range of 0 W up to 41 W (adjustable in 100 mW steps).

MIN

Set the OPP value to minimum.

MAX

Set the OPP value to maximum.

Default unit: W

Example:

```
INST OUT1
```

```
POW:PROT:LEV 5
```

Set the OPP value of channel 1 to 5 W.

```
POW:PROT:LEV? -> 5
```

Return the selected channel OPP value.

Manual operation: See "[Level](#)" on page 65

[SOURce:]POWER:PROTection:TRIPped?

Queries the OPP tripped status of the previous selected channel

Return values:

<arg0> 1 | 0

1

OPP is tripped.

0

OPP is not tripped.

Example:

```
INST OUT1
```

```
POW:PROT:TRIP? -> 0
```

OPP tripped status of Ch 1 has not tripped.

Usage:

Query only

Manual operation: See "[Overpower Protection \(OPP\)](#)" on page 65

[SOURce:]POWER:PROTection[:STATe] <arg0>**[SOURce:]POWER:PROTection[:STATe]?**

Defines or queries the OPP tripped status for the previous selected channel.

Parameters:

<arg0> ON | OFF | 1 | 0

ON | 1

OPP is activated.

OFF | 0

OPP is deactivated.

Example:

```
INST OUT1
```

```
POW:PROT ON
```

OPP of Ch 1 is activated.

```
POW:PROT?
```

Returns the OPP tripped status of the selected channel.

Manual operation: See "[Mode](#)" on page 65

[SOURce:]POWer:PROTection:CLEar

Resets the OPP tripped status of the selected channel. If the OPP has tripped, the red blinking OPP message on the display will be cleared for the selected channel.

Usage: Event

Manual operation: See "[Overpower Protection \(OPP\)](#)" on page 65

8.4 Measurement commands

The MEASure subsystem provides commands to query the voltage and current values of a channel.

MEASure[:SCALar]:CURRent[:DC]?

Queries the measured current value of the previous selected channel.

Return values:

<Current> **<numeric_value>**
Return the measured current.
Default unit: A

Example: MEAS:CURR? -> 1.000

Usage: Query only

MEASure[:SCALar]:POWer?

Queries the measured power value of the previous selected channel.

Return values:

<Power> **<Numeric_value>**
Return the measured power value.
Default unit: W

Example: MEAS:POW? -> 3.00E+00
Return the measured power value of the selected channel.

Usage: Query only

MEASure[:SCALar][:VOLTage][:DC]?

Queries the measured voltage value of the previous selected channel.

Return values:

<Voltage> **<numeric_value>**
Return the measured voltage.
Default unit: V

Example: MEAS? -> 1.000E+00

Usage: Query only

8.5 Advanced operating commands

The following shows the subsystem that contains the commands for configuring the arbitrary function, EasyRamp and digital I/O functions.

8.5.1 Arbitrary commands

The `ARBitrary` subsystem contains the commands for configuring an arbitrary sequence for the output channels.

Example: Configuring an arbitrary sequence

This programming example generates an arbitrary sequence for a selected channel. The sequence starts at 1 V and 1 A for 1 sec, and both values are incremented each second by 1. The generated arbitrary waveform is transferred to Ch 1. When activated, the R&S NGA100 provides the arbitrary waveform at the output of the selected channel, and repeats it 10 times.

```
// *****
// Define and start the EasyArb sequence
// *****
// selects channel 1
INST OUT1
// defines the sequence, i.e. starting at 1V, 1A for 1sec,
// and increments the voltage and current each second by 1
ARB:DATA "1,1,1000,2,2,1000,3,3,1000"
// sets the repetition rate
ARB:REP 10
// ARB:REP? queries the set number of repetitions
// ARB:POIN? queries the number of arbitrary points of EasyArb waveform
// Enable the arbitrary sequence
ARB 1
// starts the sequence in channel 1
// ARB 0 stops the sequence in the selected channel
// turns on the output
OUTP ON
// *****
// Save and recall an arbitrary sequence
// *****
// saves the sequence into the internal memory, e.g. M1
ARB:SAV 1
// recalls a previously saved sequence from the internal memory
ARB:RCL 1
// starts the previous transferred EasyArb waveform in channel 1
ARB:START
// stops the EasyArb waveform in channel 1 if EasyArb is running
ARB:STOP
// clears the arbitrary table data for the selected channel
ARB:CLEAR
```

ARbitrary:CLEar

Clears the previous defined arbitrary waveform data for channel 1.

Usage: Event

Manual operation: See "[Clear Data Points](#)" on page 74

ARbitrary:DATA <arg0>**ARbitrary:DATA?**

Defines or queries the arbitrary points for channel 1. The dwell time between two points is from 10 ms to 600 s.

Parameters:

<arg0> <Voltage1, Current1, Time1, Voltage2, Current2, Time2,..., Voltage128, Current128, Time128>

Voltage1 ... Voltage128

Defines the arbitrary points of the voltage.

Current1 ... Current128

Defines the arbitrary points of the current.

Time1 ... Time128

Defines the arbitrary points of the time (The unit for time is ms).

Example:

```
ARB:DATA "10.5, 3, 10, 20, 2, 1000, 15, 2.1, 10000"
```

Manual operation:

See ["N"](#) on page 73

See ["Voltage"](#) on page 73

See ["Current"](#) on page 74

See ["Duration"](#) on page 74

See ["Apply EasyArb Data"](#) on page 74

ARbitrary:RCL <arg0>

Recalls EasyArb settings and previous defined arbitrary points from the respective memory locations M1-M5.

Parameters:

<arg0> Range: 0..4

Usage:

Setting only

Manual operation:

See ["\[Store Recall\]"](#) on page 78

ARbitrary:REPetitions <Repetitions>**ARbitrary:REPetitions?**

Defines or queries the repetition of the defined arbitrary waveform for channel 1.

Note: If the repetition is set to "0", the arbitrary waveform repeats continuously.

Parameters:

<Repetitions> 0..255

Example:

```
ARB:REP 10
```

Set the repetition rate of the defined arbitrary waveform as 10.

```
ARB:REP? -> 10
```

Return the defined repetition rate of the selected channel.

Manual operation:

See ["EasyArb Repetition"](#) on page 73

ARbitrary:POINTS?

Returns the number of arbitrary points of EasyArb waveform.

Return values:

<arg0>

Usage: Query only

Manual operation: See "[Number of Data Points](#)" on page 73

ARbitrary[:STATE] <arg0>**ARbitrary[:STATE]?**

Sets or queries the EasyArb state ON, i.e. Ch 1 is ready to run arb waveform.

Parameters:

<arg0> {OFF | ON}

ON

EasyArb state is activated.

OFF

EasyArb state is deactivated.

Manual operation: See "[EasyArb Mode on Ch 1](#)" on page 73

ARbitrary:SAV <arg0>

Saves EasyArb settings and previous defined arbitrary points into the respective memory locations M1-M5.

Parameters:

<arg0> Range: 0..4

Example:

```
INST 1
ARB:DATA "10,1,1000,5,2,2000"
ARB:REP 10
ARB:SAV 1
```

Usage: Setting only

Manual operation: See "[\[Store Recall\]](#)" on page 78

ARbitrary:START

Starts the previous transferred EasyArb waveform in channel 1 if EasyArb is enabled.

Usage: Event

Manual operation: See "[Apply EasyArb Data](#)" on page 74

ARbitrary:STOP

Stops the EasyArb waveform in channel 1 if EasyArb is running.

Usage: Event

Manual operation: See ["Apply EasyArb Data"](#) on page 74

8.5.2 EasyRamp commands

The `VOLTage:RAMP` subsystem contains the commands for configuring the ramp function for the output channels.

[SOURce:]VOLTage:RAMP:DURation <Time>

[SOURce:]VOLTage:RAMP:DURation?

Sets or queries the EasyRamp duration of the previous selected channel in seconds. 0.01 s to 10 s in steps of 0.01 s.

Parameters:

<Time> Range: 0.01 to 10
 *RST: 0.01
 Default unit: s

Manual operation: See ["Ramping Time"](#) on page 75

[SOURce:]VOLTage:RAMP[:STATe] <arg0>

[SOURce:]VOLTage:RAMP[:STATe]?

Defines or queries the EasyRamp state for the previous selected channel.

Parameters:

<arg0> {OFF | ON}
 ON
 EasyRamp function is activated.
 OFF
 EasyRamp function is disabled.

Manual operation: See ["Output Ramping"](#) on page 75

8.5.3 DIO commands

The `DIO` subsystem contains the commands for configuring a digital I/O function for the output channels.

TRIGger:DIRection:DIO<IO> <arg0>

TRIGger:DIRection:DIO<IO>?

Sets or queries the specified digital I/O line to function as trigger input or trigger output.

Suffix:

<IO> 1..4

Parameters:

<arg0> OUTPut | INPut

Example: TRIG:DIR:DIO2 OUT

Manual operation: See "[Direction](#)" on page 68

TRIGger[:ENABLE]:DIO<IO> <arg0>
TRIGger[:ENABLE]:DIO<IO>?

Sets or queries the state of the specified digital I/O line.

The state is disabled when any setting has been changed.

Suffix:

<IO> 1..4

Parameters:

<arg0> {OFF | ON}

ON

Enable the state for digital I/O line.

OFF

Disable the state for digital I/O line.

*RST: OFF

Manual operation: See "[Status](#)" on page 69

TRIGger:IN:ARBitrary:DIO<IO> <arg0>
TRIGger:IN:ARBitrary:DIO<IO>?

Sets or queries the operation mode to start EasyArb with the trigger input signal.

Suffix:

<IO> 1..4

Parameters:

<arg0> PULSe | LEVeL

PULSe

Starts EasyArb when trigger signal activated.

LEVeL

Starts EasyArb when trigger signal activated and stops when trigger signal de-activated.

*RST: PULSe

Example: TRIG:IN:ARB:DIO1 PULS

Manual operation: See "[Condition](#)" on page 69

TRIGger:IN:RESPonse:DIO<IO> <arg0>
TRIGger:IN:RESPonse:DIO<IO>?

Sets or queries the output response of the trigger input of the specified digital I/O line.

Suffix:

<IO> 1..4

Parameters:

<arg0> ON | OFF | TOGGle | INHibit | ARBitary

ON

Output is switched on.

OFF

Output is switched off.

TOGGle

Output state is toggled.

INHibit

Output state remains off as long as the trigger input signal is activated.

ARBitary

Starts the EasyArb function. If level signal is selected, the Easy-Arb function is stopped when the trigger input signal is deactivated.

*RST: OFF

Manual operation: See "[Condition](#)" on page 69**TRIGger:IN:SOURce:DIO<IO>** <arg0>**TRIGger:IN:SOURce:DIO<IO>?**

Sets or queries the source under control of the trigger input of the specified digital I/O line.

Suffix:

<IO> 1..4

Parameters:<arg0> **CH1**

Trigger input source from Ch 1.

CH2

Trigger input source from Ch 2.

*RST: CH1

Manual operation: See "[Channel](#)" on page 69**TRIGger:LOGic:DIO<IO>** <arg0>**TRIGger:LOGic:DIO<IO>?**

Sets or queries the trigger logic ("Active High" / "Active Low") of the specified digital I/O line.

Suffix:

<IO> 1..4

Parameters:

<arg0> LOW | HIGH
 *RST: HIGH

Manual operation: See "[Logic](#)" on page 69

TRIGger:MASTer[:STATe] <arg0>

TRIGger:MASTer[:STATe]?

Defines or queries the master enable state for the digital I/O interface. The master enable state is disabled if any setting is changed.

Parameters:

<arg0> {OFF | ON}
 ON
 "Master Enable" state is activated for all DIO interfaces.
 OFF
 "Master Enable" state is deactivated for all DIO interfaces.
 *RST: OFF

Manual operation: See "[Master Enable](#)" on page 68

TRIGger:OUT:CONDition:DIO<IO> <arg0>

Sets the trigger condition of the trigger output of the specified digital I/O line.

The line triggers when the output of the specified control source is turned off or on.

Suffix:

<IO> 1..4

Parameters:

<arg0> ON | OFF | FUSetrip | CCMoDe | VOLTlevel | CURRlevel |
 CRITevent | ARbitrary
 ON
 Trigger output is turned on.
 OFF
 Trigger output is turned off.
 FUSetrip
 Trigger output is linked to fuse tripped event.
 VOLTlevel
 Trigger output is linked to a set voltage level event.
 CURRlevel
 Trigger output is linked to a set current level event.
 CRITevent
 Trigger output is linked to a critical triggered event.
 ARbitrary
 Trigger output is linked to a EasyArb event.
 *RST: ON

Manual operation: See "[Condition](#)" on page 69

TRIGger:OUT:CRITevent:DIO<IO> <arg0>
TRIGger:OUT:CRITevent:DIO<IO>?

Sets or queries the critical event of the trigger output of the specified digital I/O line.

Suffix:

<IO> 1..4

Parameters:

<arg0> OVP | OPP | OTP

OVP

Trigger output is linked to the OVP event.

OPP

Trigger output is linked to the OPP event.

OTP

Trigger output is linked to the OTP event.

*RST: OVP

Manual operation: See "[Condition](#)" on page 69

TRIGger:OUT:CURRlevel:DIO<IO> <Current>
TRIGger:OUT:CURRlevel:DIO<IO>?

Sets or queries the threshold current level of the trigger output of the specified digital I/O line.

Triggers when output current level exceeds or equals to the set level.

Suffix:

<IO> 1..4

Parameters:

<Current> *RST: 3.000
 Default unit: A

Manual operation: See "[Condition](#)" on page 69

TRIGger:OUT:SOURce:DIO<IO> <arg0>
TRIGger:OUT:SOURce:DIO<IO>?

Sets or queries the control source of the trigger output of the specified digital I/O line.

Suffix:

<IO> 1..4

Parameters:

<arg0> **CH1**
 Trigger output source from Ch 1.
CH2
 Trigger output source from Ch 2.

*RST: CH1

Manual operation: See "[Channel](#)" on page 69

TRIGger:OUT:VOLTlevel:DIO<IO> <Voltage>
TRIGger:OUT:VOLTlevel:DIO<IO>?

Sets or queries the threshold voltage level of the trigger output of the specified digital I/O line.

Triggers when output voltage level exceeds or equals to the set level.

Suffix:

<IO> 1..4

Parameters:

<Voltage> *RST: 0.0
 Default unit: V

Manual operation: See "[Condition](#)" on page 69

TRIGger:RCL <arg0>

Recalls DIO settings from the respective memory locations M1-M5.

Parameters:

<arg0> Range: 0..4

Example: TRIG:RCL 1

Usage: Setting only

Manual operation: See "[\[Store Recall\]](#)" on page 78

TRIGger:SAV <arg0>

Saves DIO settings into the respective memory locations M1-M5

Parameters:

<arg0> Range: 0..4

Example: TRIG:SAV 1

Usage: Setting only

Manual operation: See "[\[Store Recall\]](#)" on page 78

8.6 Data and file management commands

The DATA and HCOpy subsystems contain commands for managing the files in the instrument and external USB stick.

The LOG subsystem contains the commands for managing the data logging of the instrument.

HCOPY:DATA?

Queries current screen content. BMP format is supported.

Return values:

<arg0>

Usage: Query only

HCOPY:SIZE:X?

Returns the horizontal expansion of the screenshots.

Return values:

<arg0>

Usage: Query only

HCOPY:SIZE:Y?

Returns the vertical expansion of the screenshots.

Return values:

<arg0>

Usage: Query only

LOG[:STATe] <arg0>

LOG[:STATe]?

Sets or queries the data logging state.

Parameters:

<state>

ON | 1

Data logging function is enabled.

OFF | 0

Data logging function is disabled.

*RST: 0

Example:

LOG ON

LOG? -> 1

Data logging function is activated.

Manual operation: See "[Log]" on page 45

See "[Log]" on page 71

DATA:DATA? <arg0>

Returns the logging file data of the selected file.

Parameters:

<filepath> Filepath of the logging file data.

Example:

```
DATA:DATA? "log-20210101T101632.csv" ->
#Device,NGA142
#Device Name,rs-instrument.local
#Format,LOG
#Date,2021-1-1
#Version,2.001 009F41098
#Logging Interval[s],0.1 Time-
stamp,U1[V],I1[A],P1[W],U2[V],I2[A],P2[W]
10:16:33.370,16.855,0.00010,0.00,12.028,0.00026,0.00,
10:16:33.484,16.855,0.00010,0.00,12.028,0.00026,0.00
```

Usage: Query only

Manual operation: See "[Log]" on page 71

DATA:LIST?

Queries all files in internal memory ('/int/') and external memory ('/USB').

Example:

```
DATA:LIST? ->
"log-20210101T101557.csv,log-20210101T101632.csv,log-2021
0101T110506.csv,"
```

Usage: Query only

Manual operation: See "[Log]" on page 71

8.7 Firmware update

The following shows the subsystem that contains the commands for firmware update function.

DIAGnostic:SERVice:FWUP <arg0>

Starts instrument firmware update remotely.

For more information, see [Chapter 7.14.6, "Updating the firmware"](#), on page 97.

Parameters:

<arg0>

Example:

```
DIAGnostic:SERVice:FWUP "NGA1xx"
```

Usage: Setting only

Manual operation: See "[Start Update from USB](#)" on page 99

9 Troubleshooting

- [Displaying status information](#)..... 142
- [Problems during firmware update](#)..... 142
- [Problems with remote control over LAN](#)..... 143
- [Contacting customer support](#)..... 143

9.1 Displaying status information

The R&S NGA100 displays notifications to inform you on current settings and states. It distinguishes between status, information, and warning and error notifications.

9.2 Problems during firmware update

The firmware update is described in [Chapter 7.14.6, "Updating the firmware"](#), on page 97.

Solutions for potential problems that can occur during firmware update are described in the following sections.

Firmware update was interrupted

If, for example, a power cut happens during the firmware update, problems can occur.

1. Perform the firmware update again. Sometimes, a further update fixes the problems.
2. If you nevertheless cannot update the R&S NGA100, contact the local service representative, see [Chapter 9.4, "Contacting customer support"](#), on page 143.

Firmware update was aborted

If there is not enough free memory space, the firmware update aborts. The instrument displays an error message.

- ▶ Start the firmware update again.

9.3 Problems with remote control over LAN

9.3.1 Cannot establish a LAN connection

If you have problems to establish a LAN connection as described in [Chapter 7.13.1.1, "LAN connection"](#), on page 78:

1. Check if the TCP/IP address information is valid.
2. Assign the IP address manually, e.g. if the network does not support DHCP configuration.

9.3.2 Cannot communicate over LAN

If you have problems to establish the LAN communication:

1. Refer to the application note [1SL374: How to communicate with R&S devices using VISA](#), that provides comprehensive information on configuring the interfaces, required drivers, and testing the communication.
2. If you still have problems, contact the customer support.

9.4 Contacting customer support

Technical support – where and when you need it

For quick, expert help with any Rohde & Schwarz product, contact our customer support center. A team of highly qualified engineers provides support and works with you to find a solution to your query on any aspect of the operation, programming or applications of Rohde & Schwarz products.

Contact information

Contact our customer support center at www.rohde-schwarz.com/support, or follow this QR code:



Figure 9-1: QR code to the Rohde & Schwarz support page

10 Transport

Lifting and carrying

See "[Lifting and carrying the product](#)" on page 10.

Packing

Use the original packaging material. It consists of antistatic wrap for electrostatic protection and packing material designed for the product.

If you do not have the original packaging, use similar materials that provide the same level of protection.

Securing

When moving the product in a vehicle or using transporting equipment, make sure that the product is properly secured. Only use items intended for securing objects.

Transport altitude

Unless otherwise specified in the data sheet, the maximum transport altitude without pressure compensation is 4500 m above sea level.

11 Maintenance, storage and disposal

The product does not require regular maintenance. It only requires occasional cleaning. It is however advisable to check the nominal data from time to time.

- [Cleaning](#)..... 146
- [Changing fuses](#)..... 146
- [Internal battery replacement](#)..... 146
- [Storage](#)..... 147
- [Disposal](#)..... 147

11.1 Cleaning

How to clean the product is described in "[Cleaning the product](#)" on page 12.

Do not use any liquids for cleaning. Cleaning agents, solvents, acids and bases can damage the front panel labeling, plastic parts and display.

11.2 Changing fuses

If the product does not start, it is possible that a blown fuse is the cause. The fuse is located in the socket of the power supply.

For details on changing fuses, see "[Replacing the power fuse](#)" on page 24.

11.3 Internal battery replacement

An internal CR2032 coin cell battery powers the real-time clock circuit which provides continuous time stamp for the instrument. If the battery fails, the system clock and time stamp for the logging function are not available but other instrument functions are not affected.

Under normal usage at room temperature, the battery is expected to last up to 10 years. However, the battery life expectancy is reduced if the device is stored at temperature above 40°C for an extended period of time.



If the instrument cannot retain the date and time settings after turning off the AC input, the battery is discharged.

Contact your local service partner for battery replacement.

11.4 Storage

Protect the product against dust. Ensure that the environmental conditions, e.g. temperature range and climatic load, meet the values specified in the data sheet.

11.5 Disposal

Rohde & Schwarz is committed to making careful, ecologically sound use of natural resources and minimizing the environmental footprint of our products. Help us by disposing of waste in a way that causes minimum environmental impact.

Disposing electrical and electronic equipment

A product that is labeled as follows cannot be disposed of in normal household waste after it has come to the end of its service life. Even disposal via the municipal collection points for waste electrical and electronic equipment is not permitted.



Figure 11-1: Labeling in line with EU directive WEEE

Rohde & Schwarz has developed a disposal concept for the eco-friendly disposal or recycling of waste material. As a manufacturer, Rohde & Schwarz completely fulfills its obligation to take back and dispose of electrical and electronic waste. Contact your local service representative to dispose of the product.

12 Applications

12.1 Parallel and series mode

To increase output voltage and currents, it is possible to operate the channels in series or parallel mode. In general, the output voltages of R&S NGA100 to be combined are independent.

For safety information, see [Chapter 5.1.6, "Connecting to power"](#), on page 24.

12.1.1 Series mode

This type of interconnection adds the individual output voltages. The same current flows through all outputs. The current limits for the outputs wired in series should be set to the identical value. If one of the outputs exceeded the current limit, the total voltage will naturally collapse. See [Chapter 6.3, "Operation modes"](#), on page 50.

It is advisable to set the voltages of all connected channels voltages to a similar value to distribute the loads evenly (not absolutely necessary). When both channels are connected in a series mode and if a (low resistance) load is connected; there is a chance of damaging a channel when that channel is switched off. This is due to the protection diode working as a bypass to connect the other channel in a series mode. Once the protection diode is shorted, the channel is defective.

Therefore, it is necessary to always have all channels or no channel at all switched on.



If the instrument switches to constant current (CC) mode during a series connection, the voltage display becomes inaccurate.

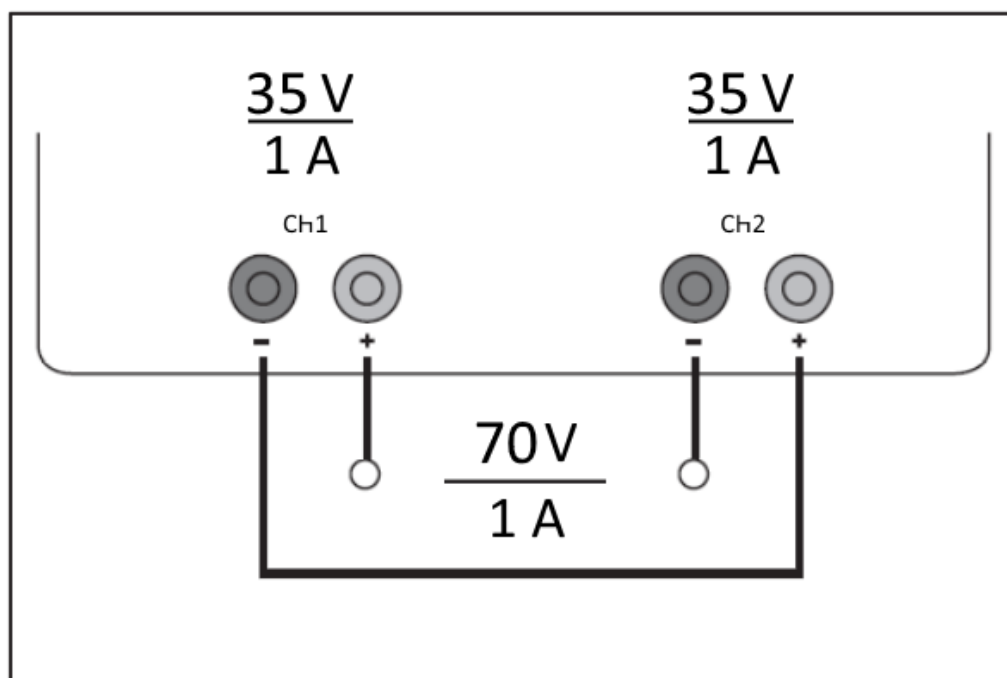

Figure 12-1: Example of series connection

12.1.2 Parallel mode

If it is necessary to increase the total current, the power supply outputs must be wired in parallel. The maximum total current is the sum of the individual currents of all sources connected in parallel. The output voltages for the individual outputs should be set to the same voltage value as precisely as possible. For slight voltage differences, it is common in this operating mode to first charge a voltage output up to the current limit; the other voltage output provides the remaining current. See ["Principles of operation in parallel mode"](#) on page 150.

For power supplies that are connected in parallel, it is possible that compensating currents flow within the power supplies. The use of power supplies by other manufacturers, which are potentially not overload proof, can cause destruction of these units as currents may be distributed unevenly.

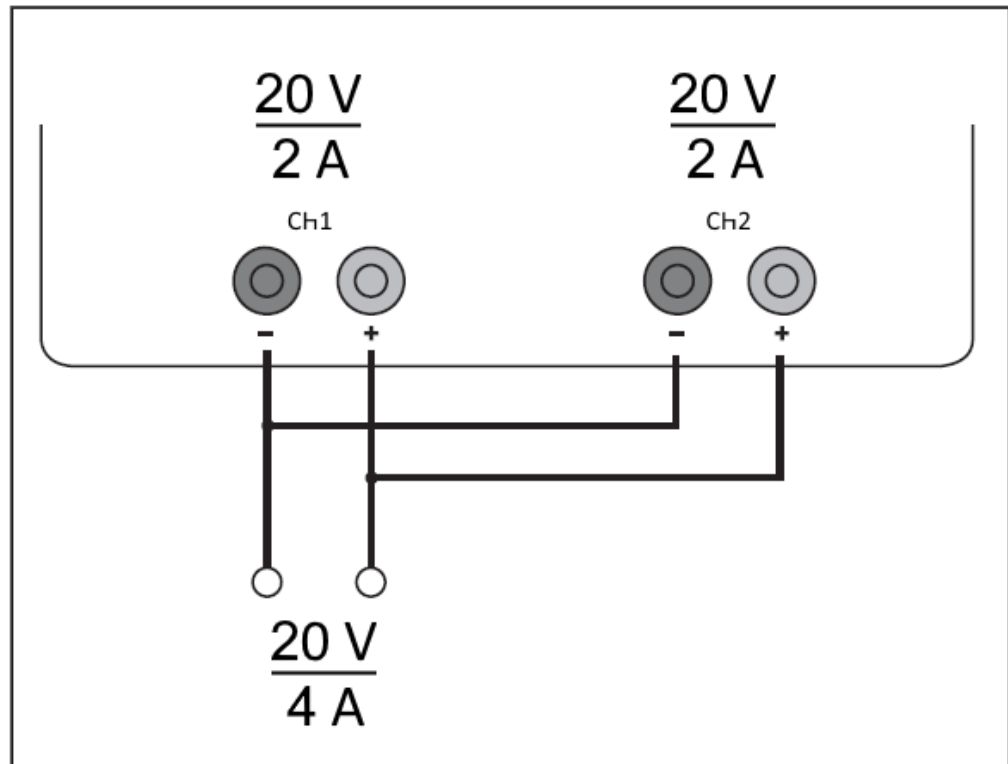

Figure 12-2: Example of parallel connection

Principles of operation in parallel mode

Generally, a higher current is first supplied from the channel with the higher output voltage. Once this channel reaches its power limit, the remaining current is made available by the channel that is connected in parallel. In this scenario, it is unpredictable which channel supplies the higher current because it is also possible for channels with identical voltage values to display a low voltage difference.

By increasing the voltage slightly, the load distribution can be manipulated. If the voltage for a channel is to be increased by 50 mV, for instance (by a set of identical cables), the current will initially be provided by this channel.

If you wish to distribute the load to multiple channels, it is recommended to set the current limit of the channel that is to supply the main current to a fraction of the current. This approach handles the semiconductor with care and improves the heat dissipation, as the power loss is distributed more evenly.

Annex

A Additional basics on remote control

A.1 Messages and SCPI command structure

A.1.1 Messages

Instrument messages are employed in the same way for all interfaces, if not indicated otherwise in the description.

- Structure and syntax of the instrument messages: [Chapter A.1.2, "SCPI command structure"](#), on page 152
- Detailed description of all messages: [Chapter 8, "Remote control commands"](#), on page 102

There are different types of instrument messages:

- Commands
- Instrument responses

Commands

Commands (program messages) are messages which the controller sends to the instrument. They operate the instrument functions and request information. The commands are subdivided according to two criteria:

Effects on the instrument:

- Setting commands cause instrument settings such as a reset of the instrument or setting the output voltage.
- Queries return data for remote control, e.g. for identification of the instrument or polling a parameter value. Queries are formed by appending a question mark to the command header.

Applied standards:

- The function and syntax of the common commands are precisely defined in standard IEEE 488.2. If implemented, they are used identically on all instruments. They refer to functions such as management of the standardized status registers, reset and self-test.
- Instrument control commands refer to functions depending on the features of the instrument such as voltage settings. Many of these commands have also been standardized by the SCPI committee. These commands are marked as "SCPI compliant" in the command reference chapters. Commands without this SCPI label

are device-specific, however, their syntax follows SCPI rules as permitted by the standard.

Instrument responses

Instrument responses (response messages and service requests) are messages which the instrument sends to the controller after a query. They can contain measurement results, instrument settings and information on the instrument status.

A.1.2 SCPI command structure

SCPI commands consist of a so-called header and, usually, one or more parameters. The header and the parameters are separated by a whitespace. The headers can consist of several mnemonics (keywords). Queries are formed by appending a question mark directly to the header. The commands can be either device-specific or device-independent (common commands). Common and device-specific commands differ in their syntax.

Syntax for common commands

Common (= device-independent) commands consist of a header preceded by an asterisk (*) and possibly one or more parameters.

Table A-1: Examples of common commands

Command	Command name	Description
*RST	Reset	Resets the instrument.
*ESE	Event Status Enable	Sets the bits of the event status enable registers.
*ESR?	Event Status Query	Queries the content of the event status register.
*IDN?	Identification Query	Queries the instrument identification string.

Syntax for device-specific commands

For demonstration purposes only, assume the existence of the following commands for this section:

- MEASure:CURRent[:DC]?
- MEASure:VOLTage[:DC]?
- FUSE[:STATe] {0 | 1}
- FUSE[:STATe]?

Long and short form

The mnemonics feature a long form and a short form. The short form is marked by uppercase letters, the long form corresponds to the complete word. You can enter either the short form or the long form; other abbreviations are not permitted.

Example:

MEASure:CURRent? is equivalent to MEAS:CURR?.

**Case-insensitivity**

Uppercase and lowercase notation only serves to distinguish the two forms in the manual, the instrument itself is case-insensitive.

Numeric suffixes

If a command can be applied to multiple instances of an object, e.g. specific channels or sources, the required instances can be selected by a suffix added to the command. Numeric suffixes are indicated by angular brackets (<1...4>, <n>, <i>). They are replaced by a value without brackets in the command.

SCPI prescribes that suffix counting starts with 1. Suffix 1 is the default state and used when no suffix is specified.

Example:

Definition: CHANnel<n>:LIMit<n>:SOURCE?

Command: CHAN:LIM2:SOUR?

This command queries the 2nd limit in channel 1.

Optional mnemonics

Some command systems permit inserting or omitting certain mnemonics in the header. These mnemonics are marked by square brackets. The instrument must recognize the long command to comply with the SCPI standard. Some commands are shortened by these optional mnemonics.

**Optional mnemonics with numeric suffixes**

Do not omit an optional mnemonic if it includes a numeric suffix that is relevant for the effect of the command.

Example:

CHANnel<n>[:ACQuisition]:MODE?

CHAN:ACQ:MODE? is equivalent to CHAN:MODE?.

Note that an optional mnemonic with a numeric suffix automatically selects 1 if you omit the optional part of the command, e.g.:

Definition: CHANnel<n>:MEASurement:FUNCTions? [<n>]

Command: CHAN:MEAS:FUNC? queries the list of all function names in channel 1.

To query a single function, e.g. at index 3 in channel 2, include the optional CHANnel suffix and the index of the function.

Command: CHAN2:MEAS:FUNC? 3

FUSE[:STATe] { ON }

FUSE:STAT ON is equivalent to FUSE ON.

A.1.3 SCPI parameters

Many commands are supplemented by a parameter or a list of parameters. The parameters must be separated from the header by a whitespace (ASCII code 0 to 9, 11 to 32 decimal, e.g. blank). If several parameters are specified in a command, they are separated by a comma ",".

Allowed parameters are:

- Numeric values
- Special numeric values
- Boolean parameters
- Text
- Character strings
- Block data

The required parameters and the allowed value range are specified in the command description.

Numeric values

You can enter numeric values either with sign, decimal point or exponentially ("E" or "e"). The mantissa range is up to 255 characters, the value range of the exponent is -32000 to 32000. Values exceeding the resolution of the instrument are rounded up or down.

Example:

```
VOLT 10V = VOLT 10
VOLT 100mV = VOLT 0.1
VOLT 500mV is equivalent to VOLT 500e-3.
```

Special numeric values

The text listed below are interpreted as special numeric values. In the case of a query, the numeric value is provided.

- MIN/MAX
- MINimum and MAXimum denote the minimum and maximum value

Example:

```
VOLT:PROT? MAX
```

Returns the maximum numeric value.

Boolean parameters

Boolean parameters represent two states:

- **On** (logically true), is represented by "On" or the numeric value "1"
- **Off** (logically false), is represented by "Off" or the numeric value "0"

The instrument returns the numerical value when queried.

Example:

```
OUTP:STAT ON
OUTP:STAT? -> 1
```

Text

Text parameters observe the syntactic rules for key words, i.e. they can be entered using a short or long form. Like any parameter, they have to be separated from the header by a white space.

Example:

```
ARBitrary:TRIGgered:MODE
ARBitrary:TRIGgered:MODE SING
ARBitrary:TRIGgered:MODE? -> "SINGle"
```

Character strings

Strings must always be entered in quotation marks (' or ").

Example:

```
SYSTem:COMMunicate:SOCKet:IPADdress "192.168.1.128"
SYSTem:COMMunicate:SOCKet:IPADdress '192.168.1.128'
```

Block data

Block data is a transmission format which is suitable for the transmission of large amounts of data. A command using a block data parameter has the following structure:

Example:

```
HEADer:HEADer #45168xxxxxxxx
```

ASCII character # introduces the data block. The next number indicates how many of the following digits describe the length of the data block. In the example, the four following digits indicate the length to be 5168 bytes. The data bytes follow. During the transmission of these data bytes all end or other control signs are ignored until all bytes are transmitted.

#0 specifies a data block of indefinite length. The use of the indefinite format requires a `NL^END` message to terminate the data block. This format is useful when the length of the transmission is not known or if speed or other considerations prevent segmentation of the data into blocks of definite length.

A.1.4 Overview of syntax elements

The following tables provide an overview of the syntax elements and special characters.

Table A-2: Syntax elements

:	A colon separates the mnemonics of a command.
;	The semicolon separates two commands within a program message. It does not alter the path.
,	A comma separates several parameters of a command.
?	A question mark forms a query.
*	An asterisk marks a common command.
"	Quotation marks introduce a string and terminate it.
	A whitespace (ASCII-Code 0 to 9, 11 to 32 decimal, e.g. blank) separates the header from the parameters.

Special characters

Table A-3: Special characters

	A vertical stroke in parameter definition indicates alternative possibilities in the sense of "or". The effect of the command differs, depending on the used parameter. Example: <ul style="list-style-type: none"> FUSE:LINK {1 2 3} FUSE:LINK 1 sets the fuse link CH 1 for the selected channel FUSE:LINK 2 sets the fuse link of CH 2 for the selected channel
[]	Mnemonics in square brackets are optional and can be inserted into the header or be omitted. Example: <ul style="list-style-type: none"> FUSE[:STATe] { ON } FUSE:STAT ON is equivalent to FUSE ON
{ }	Parameters in curly brackets are optional and can be inserted once or several times, or be omitted. Example: <ul style="list-style-type: none"> VOLTage[:LEVel][:IMMediate][:AMPLitude] {<voltage> MIN MAX UP DOWN } <p>The following are valid commands:</p> <ul style="list-style-type: none"> - VOLT MAX - VOLT MIN - VOLT 10

A.1.5 Responses to queries

A query is defined for each setting command unless otherwise specified. The query is set by the question mark at the end of the header. According to SCPI, the responses to some query commands are subject to stricter rules than in defined standard IEEE 488.2.

- The requested parameter is transmitted without a header.
ARbitrary:TRIGgered:MODE? -> "SINGLE"
- Maximum values, minimum values and all other quantities that are requested via a special text parameter are returned as numeric values.
VOLT:PROT? MAX -> 32.500
- Boolean values are returned as 0 (for Off) and 1 (for On).
OUTPut:STATe? -> 1

A.2 Command sequence and synchronization

A sequential command finishes the execution before the next command is starting. To make sure that commands are actually carried out in a certain order, each command must be sent in a separate command line.



As a general rule, send commands and queries in different program messages.

A.2.1 Preventing overlapping execution

To prevent an overlapping execution of commands the commands `*OPC`, `*OPC?` or `*WAI` can be used. All three commands cause a certain action only to be carried out after the hardware has been set. The controller can be forced to wait for the corresponding action.



The R&S NGA100 series does not support parallel processing of remote commands. If `OPC?` returns a "1", the device is able to process new commands.

Table A-4: Synchronization using `*OPC`, `*OPC?` and `*WAI`

Command	Action	Programming the controller
<code>*OPC</code>	Sets the Operation Complete bit in the ESR after all previous commands have been executed.	<ul style="list-style-type: none"> Setting bit 0 in the ESE Setting bit 5 in the SRE Waiting for service request (SRQ)
<code>*OPC?</code>	Stops command processing until 1 is returned. It occurs after the Operation Complete bit has been set in the ESR. This bit indicates that the previous setting has been completed.	Sending <code>*OPC?</code> directly after the command whose processing should be terminated before other commands can be executed.
<code>*WAI</code>	Stops further command processing until all commands have been executed before <code>*WAI</code> .	Sending <code>*WAI</code> directly after the command whose processing should be terminated before other commands are executed

Command synchronization using `*WAI` or `*OPC?` is a good choice if the overlapped command takes only little time to process. The two synchronization commands simply block overlapped execution of the command. Append the synchronization command to the overlapping command, for example:

```
SINGLE; *OPC?
```

For time consuming overlapped commands, you can allow the controller or the instrument to do other useful work while waiting for command execution. Use one of the following methods:

***OPC with a service request**

1. Set the OPC mask bit (bit no. 0) in the ESE: *ESE 1
2. Set bit no. 5 in the SRE: *SRE 32 to enable ESB service request.
3. Send the overlapped command with *OPC .
4. Wait for a service request.

The service request indicates that the overlapped command has finished.

***OPC? with a service request**

1. Set bit no. 4 in the SRE: *SRE 16 to enable MAV service request.
2. Send the overlapped command with *OPC?.
3. Wait for a service request.

The service request indicates that the overlapped command has finished.

Event status register (ESE)

1. Set the OPC mask bit (bit no. 0) in the ESE: *ESE 1
2. Send the overlapped command without *OPC, *OPC? or *WAI.
3. Poll the operation complete state periodically (with a timer) using the sequence:
*OPC; *ESR?

A return value (LSB) of 1 indicates that the overlapped command has finished.

***OPC? with a short timeout**

1. Send the overlapped command without *OPC, *OPC? or *WAI.
2. Poll the operation complete state periodically (by means of a timer) using the sequence: (short timeout); *OPC?.
3. A return value (LSB) of 1 indicates that the overlapped command has finished. In case of a timeout, the operation is ongoing.
4. Reset timeout to former value
5. Clear the error queue with SYStem:ERRor? to remove the "-410, Query interrupted" entries.

Using several threads in the controller application

Provided the programming environment of the controller application supports threads, you can use separate threads for the application GUI and for controlling the instrument using SCPI commands. A thread waiting for an *OPC? response does not block the GUI or the communication with other instruments.

List of commands

[SOURce:]CURRent:RANGe.....	114
[SOURce:]CURRent[:LEVel][:IMMediate][:AMPLitude].....	113
[SOURce:]POWer:PROTection:CLEar.....	129
[SOURce:]POWer:PROTection:LEVel.....	127
[SOURce:]POWer:PROTection:TRIPped?.....	128
[SOURce:]POWer:PROTection[:STATe].....	128
[SOURce:]VOLTage:PROTection:CLEar.....	126
[SOURce:]VOLTage:PROTection:LEVel.....	126
[SOURce:]VOLTage:PROTection:MODE.....	125
[SOURce:]VOLTage:PROTection:TRIPped?.....	125
[SOURce:]VOLTage:PROTection[:STATe].....	125
[SOURce:]VOLTage:RAMP:DURation.....	134
[SOURce:]VOLTage:RAMP[:STATe].....	134
[SOURce:]VOLTage:SENSe.....	111
[SOURce:]VOLTage[:LEVel][:IMMediate][:AMPLitude].....	112
*CLS.....	102
*ESE.....	102
*ESR?.....	103
*IDN?.....	103
*OPC.....	103
*OPT?.....	103
*RCL.....	105
*RST.....	104
*SAV.....	105
*SRE.....	104
*STB?.....	104
*TST?.....	104
*WAI.....	105
APPLY.....	114
ARBitrary:CLEar.....	131
ARBitrary:DATA.....	132
ARBitrary:POINts?.....	133
ARBitrary:RCL.....	132
ARBitrary:REPetitions.....	132
ARBitrary:SAV.....	133
ARBitrary:START.....	133
ARBitrary:STOP.....	133
ARBitrary[:STATe].....	133
DATA:DATA?.....	140
DATA:LIST?.....	141
DIAGnostic:SERVice:FWUP.....	141
FUSE:DELay.....	121
FUSE:LINK.....	121
FUSE:TRIPped?.....	122
FUSE:UNLink.....	122
FUSE[:STATe].....	122
HCOPY:DATA?.....	140

HCOPY:SIZE:X?.....	140
HCOPY:SIZE:Y?.....	140
INSTrument:NSElect.....	110
INSTrument[:SElect].....	110
LOG[:STATe].....	140
MEASure[:SCALar]:CURRent[:DC]?.....	129
MEASure[:SCALar]:POWer?.....	129
MEASure[:SCALar][:VOLTage][:DC]?.....	129
OTP:TRIPped?.....	119
OUTPut:FUSion.....	117
OUTPut:GENeral.....	117
OUTPut:MODE?.....	118
OUTPut:SElect.....	118
OUTPut[:STATe].....	116
SYSTem:BEEPer[:IMMediate].....	105
SYSTem:COMMunicate:SOCKet:DHCP[:STATe].....	107
SYSTem:COMMunicate:SOCKet:IPADdress?.....	107
SYSTem:COMMunicate:WLAN:CONNect.....	107
SYSTem:COMMunicate:WLAN:DISConnect.....	108
SYSTem:COMMunicate:WLAN:IPADdress?.....	108
SYSTem:COMMunicate:WLAN:PASSword.....	108
SYSTem:COMMunicate:WLAN:SSID.....	109
SYSTem:COMMunicate:WLAN[:STATe].....	108
SYSTem:LOCal.....	106
SYSTem:OPTion?.....	106
SYSTem:REMote.....	106
SYSTem:RWLock.....	106
SYSTem:TEST:BEEPer.....	106
SYSTem:TEST:FANCtrl.....	107
SYSTem:TEST:KEYBacklight.....	107
SYSTem:TEST:SCReen.....	107
TRIGger:DIRection:DIO<IO>.....	134
TRIGger:IN:ARBitrary:DIO<IO>.....	135
TRIGger:IN:RESPonse:DIO<IO>.....	135
TRIGger:IN:SOURce:DIO<IO>.....	136
TRIGger:LOGic:DIO<IO>.....	136
TRIGger:MASTer[:STATe].....	137
TRIGger:OUT:CONDition:DIO<IO>.....	137
TRIGger:OUT:CRITevent:DIO<IO>.....	138
TRIGger:OUT:CURRlevel:DIO<IO>.....	138
TRIGger:OUT:SOURce:DIO<IO>.....	138
TRIGger:OUT:VOLTlevel:DIO<IO>.....	139
TRIGger:RCL.....	139
TRIGger:SAV.....	139
TRIGger[:ENABLE]:DIO<IO>.....	135

Index

Symbols

*OPC	157
*OPC?	157
*WAI	157

A

Access	
Instrument	40
Activate channel output	53
Activating fuse	60
Active elements	38
Advanced commands	
Arbitrary commands	130
DIO commands	134
EasyRamp commands	134
Alphanumeric parameters	41
Apply LAN	81

B

Bench top, placing the R&S NGA100	20
Block data	
SCPI parameters	155
Boolean	
SCPI parameters	154
Bottom panel	
Voltage selector	32
Voltage selector label	32

C

Calibration certificate	16
Carrying the instrument	19
Channel fusion	58
Character strings	
SCPI parameters	155
Checking the instrument	19
Clear status	
Remote	102
Command sequence	
Remote	105
Remote control basics	157
Commands	
Remote control basics	151
Common commands	
SCPI syntax	152
Configuration commands	
Channel selecting	109
Combine voltage and current setting	114
Current setting	113
Fuse setting	119
OPP setting	126
Output setting	115
OVP setting	123
Remote sense setting	111
Voltage setting	111
Connecting	
Memory stick	27
Power	24
USB devices	27

Considerations	
EMI	23
Test setup	22
Customer support	143

D

Data entry	40
Data logging	69
Data sheet	15
Default gateway	80
Default values	
Remote	104
Device-specific commands	
SCPI syntax	152
Digital IO	65
Display	
Active elements	38
On-screen keypad	38
Display information	34
Documentation overview	15

E

EasyArb	72
EasyRamp	74
Electronic Fuse	60
EMI	
Considerations	23
Ethernet settings	80
Event status enable register (ESE)	
Remote	102
Event status register (ESR)	
Remote	103

F

Firmware update	
Notifications	142
Front panel	
Display	28
Function keys	28
Output channels	29
Power key	29
Rotary knob and arrow keys	29
USB connector	29
Front panel keys	43
Output and channel controls	43
Usage	34
Fuse	61
Fuse delay	61
Fuse linking	61
FuseLink	61
Fuses	
How to replace the power fuse	24

G

General instrument settings	90, 92
Buzzer	92
Display	92
Display brightness	92
Key fallback time	92

P	
Parameters	
Entering	41
SCPI	154
Power	
Connecting the instrument	24
Power derating	50
Power states	25
Preparing for use	19
Protection	63
Overpower protection (OPP)	63
Overvoltage protection (OVP)	63
Protocol	
LXI	86
SCPI	88
VISA	88
R	
Rack, mounting	21
Rear panel	
AC inlet with fuse holder	30
Digital I/O connector	30
Ethernet connector	30
Ground terminal	30
Kensington security slot	31
Rear panel connector	31
USB connector	30
Release notes	16
Remote access	
Apply LAN	81
Default gateway	80
Ethernet settings	80
IP Address	80
IP Mode	80
MAC address	80
MAC Status	80
Reset LAN	81
Subnet Mask	80
Remote control	34, 42
Interfaces	42
Remote control basics	
Command sequence	157
Commands	151, 152
GPIB interface messages	152
Messages	151
Responses to queries	156
SCPI command structure	152
SCPI parameters	154
Synchronization	157
Remote control commands	
Advanced commands	130
Common setting commands	102
Configuration commands	109
Data and file management commands	139
Firmware update commands	141
Measurement commands	129
System commands	105
Remote key	89
Remote sense function	57
Replace the power fuse	
How to:	24
Reset	95
Reset LAN	81
Reset values	
Remote	104
Responses to queries	
Remote control basics	156
S	
Safety instructions	9, 15
SCPI command structure	
Remote control basics	152
SCPI parameters	154
Block data	155
Boolean	154
Character strings	155
Numeric values	154
Special numeric values	154
Text	155
SCPI programmers manual	15
SCPI syntax	
Common commands	152
Device-specific commands	152
Long and short form	152
Numeric suffixes	153
Optional mnemonics	153
Special characters	156
Syntax elements	156
Security procedures	15
Self-test	
Remote	104
Service request enable register (SRE)	
Remote	104
Setting the voltage and current	52
Setting up remote control connection	89
Special characters	
SCPI syntax	156
Special numeric values	
SCPI parameters	154
Status bar information	
Channel status	36
Device status	35
Status byte	
Remote	102, 104
Status information	
Notifications	142
Store and recall	76
Subnet Mask	80
Switching on or off	25
Synchronization	
Remote control basics	157
Syntax elements	
SCPI syntax	156
System date time	99
System test	96
T	
Test setup	
Considerations	22
Text	
SCPI parameters	155
Text entry	40
Tracking function	62
Troubleshooting	142
Firmware update notifications	142
LAN communication problems	143
LAN connection problems	143
Status notifications	142

Trying out the instrument	
Activating the channels output	32
Selecting the channels	32
Setting the output voltage and current limit	32
Storing/Recalling of instrument settings	32

U

Unpacking the instrument	19
Update	97
USB connection	
USB TMC	85
USB VCP	84
User manual	15
Using the front panel keys	34

W

Wait	
Remote	105
Ways of operation	34